

MTD 900 MHz MOBILES

PRODUCT CODE MT



PRODUCT PROGRAMMING

| ORDERING NUMBER | DESCRIPTION |
|-----------------|-----------------------------------------------------------------------------------------------------------------------------------------------------------------------------------------|
| TQ3370 | PC Programming Adapter Kit. Includes Serial Interface Unit, PC to Serial Interface Unit Cable, and Auxiliary Power Supply. (Replaces TQ3310 and provides Flash Programming Capability.) |
| TQ3354 | PC Programming Cable (Interface module to radio) |
| TQ3346 | PC Programming Software (5 1/4" & 3 1/2" Disks) |

MTD 900 MHz MOBILES

PRODUCT CODE MT

PRODUCT NOMENCLATURE

| RADIO CONFIGURATION | FREQUENCY RANGE (MHz) | RF POWER | PACKAGE NUMBER | COMBINATION NUMBER |
|---------------------|-----------------------|----------|----------------|--------------------|
| Select Model | 896-940 | 15W | MT9815 | MTD98150 |
| Scan Model | 896-940 | 15W | MT9915 | MTD99150 |
| Select Model | 896-940 | 25W | MT9825 | MTD98250 |
| Scan Model | 896-940 | 25W | MT9925 | MTD99250 |

ANTENNA OPTIONS



Option **MTAN1M**

19B801182P3

900 MHz Rooftop Antenna with 15' "Pro-Flex" Cable,
Male TNC Connector, and Mount for 3/4" Diameter Hole.

MTD 900 MHz MOBILES

PRODUCT CODE MT

ACCESSORY OPTIONS

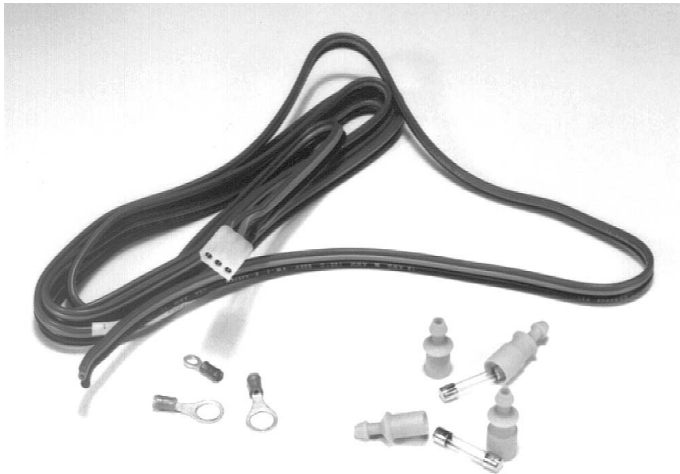

Option **MTCC7F**
19B801358P2
Power Cable 9 FT

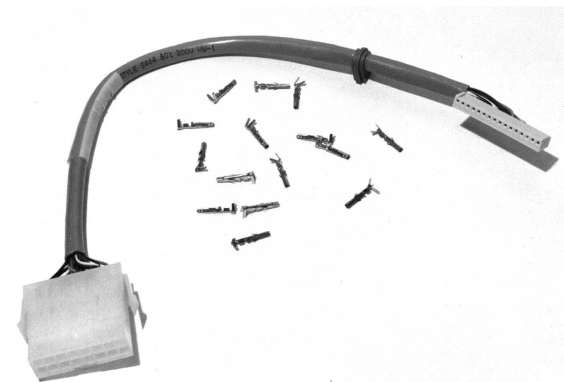

Option **MTCC3N**
19C851585P3
Option Cable

(Brings all option connections to the outside of radio - required with all external options)

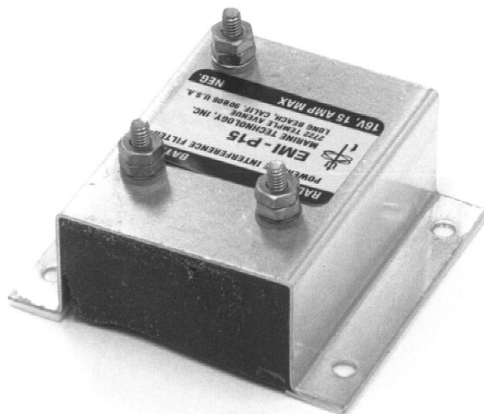

Option **MTPD1A**
19A148539G1
Noise Suppression Filter Kit
(Use to suppress electrical system noise)



Option **MTSU1C**
19A705499P1
Alarm Relay Kit
(For operating horn, lights, or other alerting device)

MTD 900 MHz MOBILES

PRODUCT CODE MT

ACCESSORY OPTIONS

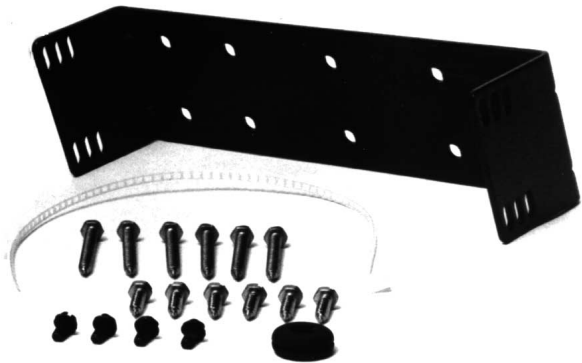

Option **MTMA1M**
19A138051G11

Standard Radio Mounting Bracket Kit



Option **MTMA1U**

Remote Modification Kit

19A705306G2 Mounting Bracket Kit

19A705306G3 Remote Mounting Kit



Option **MTZM1K**

Five Inch External Speaker Kit

19A149590P1 Speaker

19A149590P8 18 Inch Speaker Cable

(Also requires Option **MTCC3N**

Cable **19C851585P3**)

MTD 900 MHz MOBILES

PRODUCT CODE MT

COMPLETE BOARD ASSEMBLIES

| PART NUMBER | BOARD DESCRIPTION | FREQUENCY RANGE (MHz) | RF POWER |
|--------------------|------------------------------|-----------------------|----------|
| 19D902151G3 | Logic Board (A1) | 896-941 MHz | — |
| 19D901891G1 | System Board (A5) | 896-941 MHz | — |
| 19D901913G5 | Front Cap Assembly | 896-941 MHz | — |
| 19D902233G2 | Front Cap Control Board (A6) | 896-941 MHz | — |
| 19D902132G4 | RF Board (A2) | 896-941 MHz | 15W |
| 19D902132G3 | RF Board (A2) | 896-941 MHz | 25W |
| 19D902304G1 | Audio Board (A3) | 896-941 MHz | — |
| 19C851617G4 | Interconnect Board (A4) | 896-941 MHz | 15W |
| 19D902944G1 | PA Board (A4) | 896-941 MHz | 25W |

RF POWER MODULES

| BAND | PART NUMBER | CIRCUIT SYMBOL | CIRCUIT FUNCTION | BOARD WHERE USED |
|-------------|--------------------|----------------|------------------------------|------------------|
| 896-941 MHz | 19A143904P3 | U101 | Power Amplifier Module (15W) | RF Board |
| 896-941 MHz | 19A704695P2 | U104 | Exciter Module (200 mw) | RF Board |

POWER TRANSISTORS

| BAND | PART NUMBER | CIRCUIT SYMBOL | CIRCUIT FUNCTION | BOARD WHERE USED |
|-------------|--------------------|----------------|--------------------|------------------|
| 896-941 MHz | 19A702458P2 | Q151 | RF Power Amplifier | PA Board |

MTD 900 MHz MOBILES

PRODUCT CODE MT

FREQUENCY MODULES

| BAND | PART NUMBER | CIRCUIT SYMBOL | CIRCUIT FUNCTION | BOARD WHERE USED |
|-------------|---------------------|----------------|---------------------------------|------------------|
| 896-941 MHz | 19B233066G1 | Y501 | Crystal 39.455 MHz | RF Board |
| 896-941 MHz | 19A705613G2 | Z501 | Monolithic Crystal Filter | RF Board |
| 896-941 MHz | 19A705616P2 | U201 | VCO 896-941 MHz | RF Board |
| 896-941 MHz | 19B801351P12 | U204 | Reference Oscillator 14.850 MHz | RF Board |
| 896-941 MHz | 19A702511G15 | Y701 | Crystal 11.059200 MHz | Logic Board |
| 896-941 MHz | 19A702511G26 | Y725 | Crystal 11.059 MHz | Control Board |

PROGRAMMED INTEGRATED CIRCUITS

| BAND | PART NUMBER | CIRCUIT SYMBOL | CIRCUIT FUNCTION | BOARD WHERE USED |
|-------------|---------------------|----------------|------------------------------|------------------|
| 896-941 MHz | 19A705557P2 | U701 | Microprocessor (no software) | Logic Board |
| 896-941 MHz | 19A705553P1 | U704 | EEPROM (personality data) | Logic Board |
| 896-941 MHz | 19A704345P11 | U725 | Microprocessor (no software) | Control Board |

MISCELLANEOUS PARTS

| BAND | PART NUMBER | CIRCUIT SYMBOL | CIRCUIT FUNCTION | BOARD WHERE USED |
|-------------|--------------------|----------------|---------------------------|------------------|
| 896-941 MHz | 19A702169P9 | F901 | Fuse 3A Littelfuse 255003 | System Board |
| 896-941 MHz | 1R16P5 | — | Fuse 2A Bussman AGC2 | Power Cable |
| 896-941 MHz | 7102673P2 | — | Fuse 15A Bussman AGC15 | Power Cable |

MTD 900 MHz MOBILES
PRODUCT CODE MT

MISCELLANEOUS PARTS



19B801450P11
Control Panel
Select Model



19B801450P12
Control Panel
Scan Model

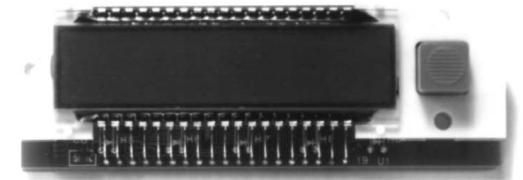

19B801459P2
LCD Assembly

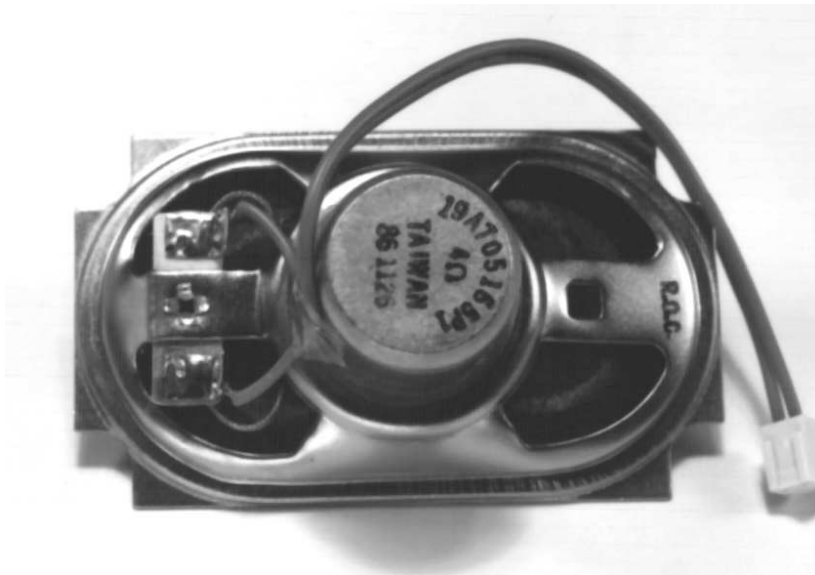

19A705165P1
Speaker



19C851585P1
Power Cable

MTD 900 MHz MOBILES
PRODUCT CODE MT

MISCELLANEOUS PARTS

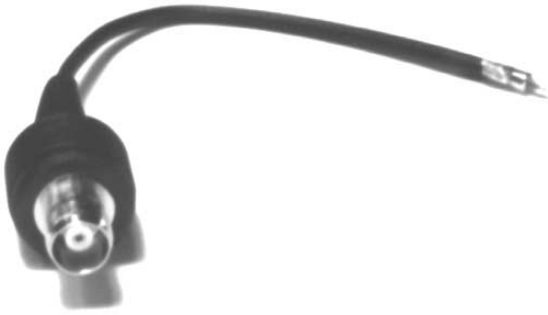

19A705301P3
RF Cable



19A705216G1
Top Cover

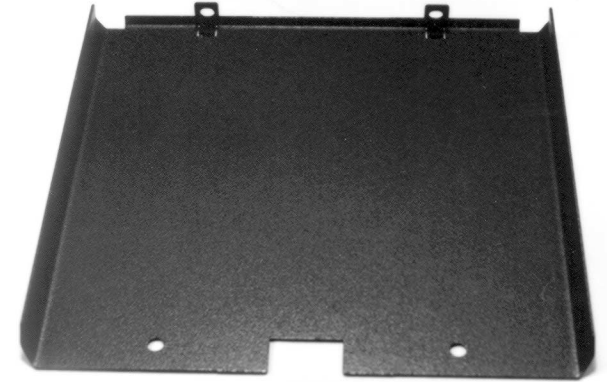

19C851573G1
Bottom Cover

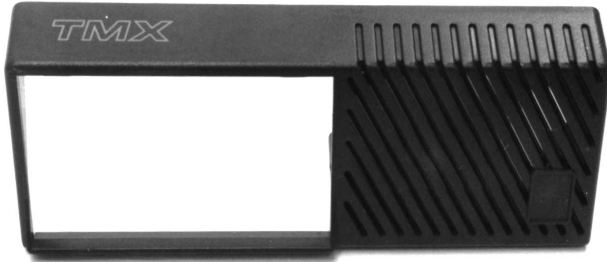

19D901890P5
Front Cap



19D901913G5
Front Cap Assembly
(Contains Control Board,
LCD Assembly and Speaker)



19D901891G1
System Board

MTD 900 MHz MOBILES
PRODUCT CODE MT

MISCELLANEOUS PARTS

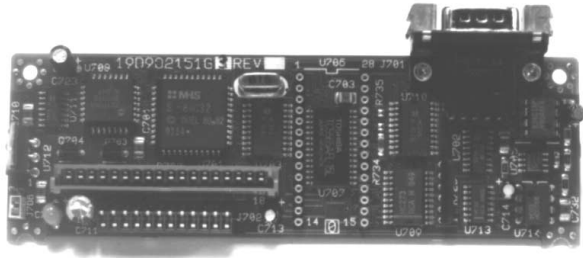

19D902151G3
Logic Board

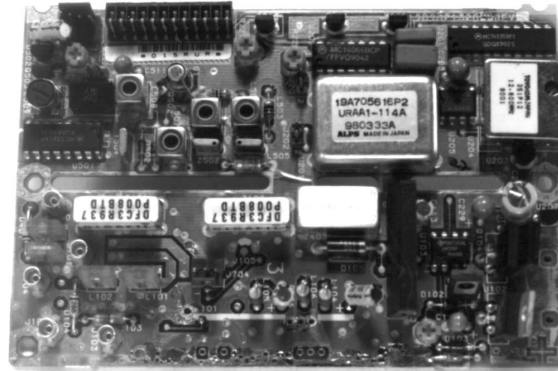

19D902132G3 RF Board 25W
19D902132G4 RF Board 15W
(Shown)

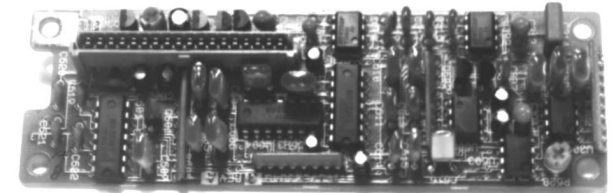

19D902304G1
Audio Board

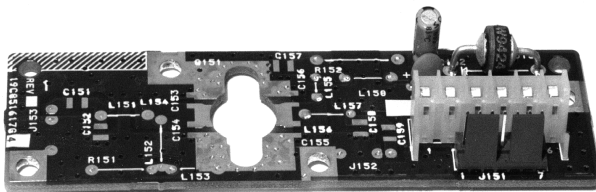

19C851617G4
Interconnect Board (15W Only)

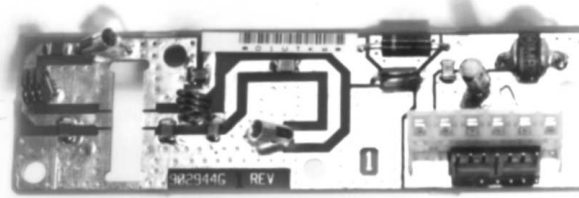

19D902944G1
PA Board (25W Only)

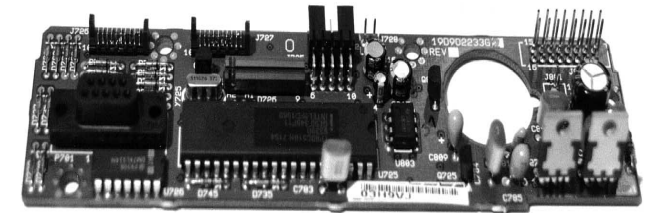

19D902233G2
Front Cap Control Board

MTD 900 MHz MOBILES

PRODUCT CODE MT

MECHANICAL PARTS BREAKDOWN

THIS IS A COMPOSITE VIEW FOR BOTH 15 WATT AND 25 WATT MODELS. CONSULT PARTS CHART FOR APPLICATION TO YOUR RADIO. (REFERENCE NUMBERS MAY DIFFER FROM MAINTENANCE MANUAL.)

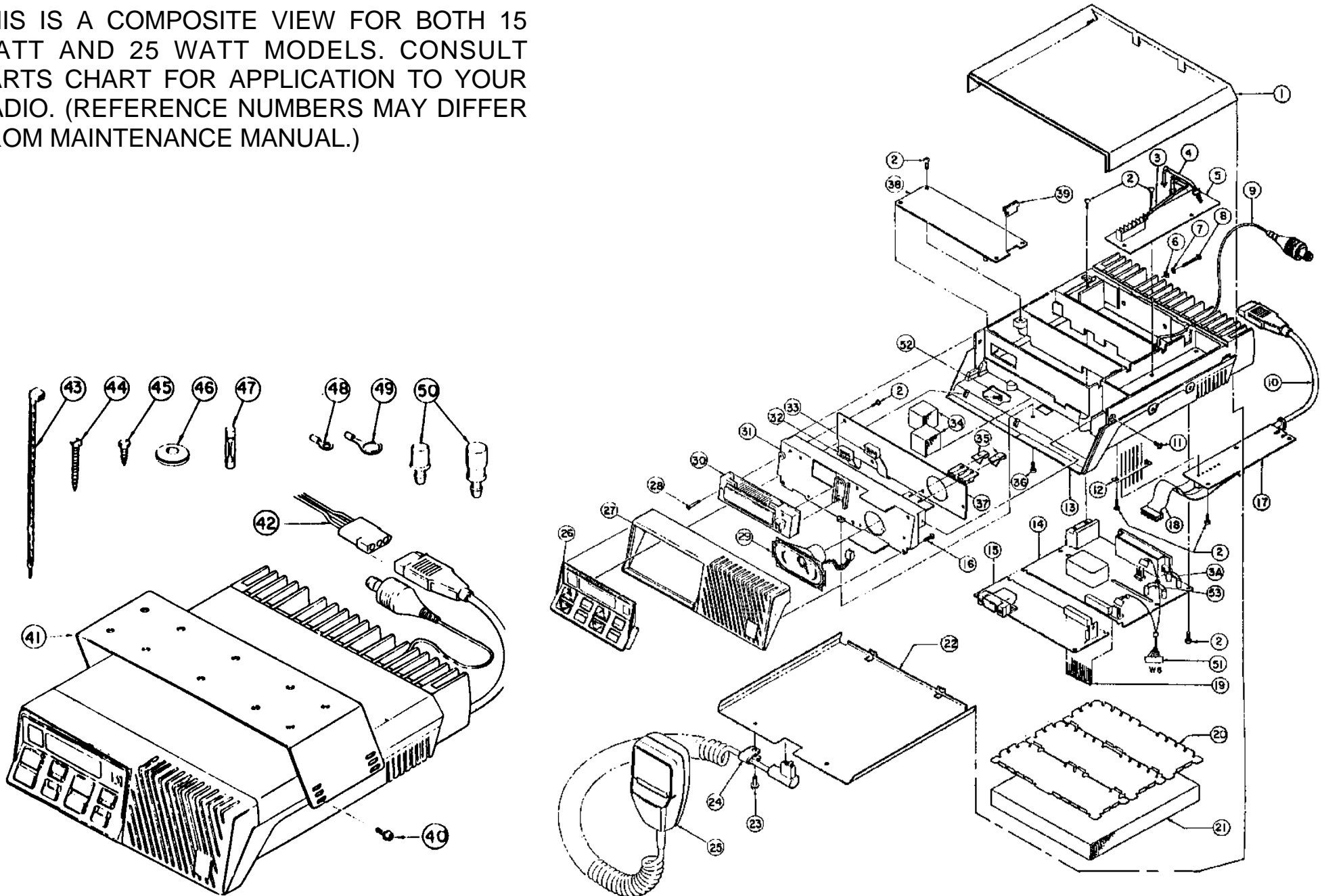

MTD 900 MHz MOBILES

PRODUCT CODE MT

MECHANICAL PARTS BREAKDOWN

| ITEM | PART NUMBER | DESCRIPTION |
|------|---------------|----------------------------------------|
| 1 | 19A705216G1 | Top Cover |
| 2 | 19A702381P508 | Screw M3.5-0.6 x 8 (Qty 20) |
| 3 | 19A704884P4 | RF Cable Assembly (W8) (25 Watt Only) |
| 3A | 19A704884P2 | RF Cable Assembly (W8) (15 Watt Only) |
| 4 | 19A704884P10 | RF Cable Assembly (W7) |
| 5 | 19D902944G1 | PA Board (A4) (25 Watt Only) |
| | 19C851617G4 | Interconnect Board (A4) (15 Watt Only) |
| 6 | 19A700033P3 | Lockwasher, M2.5 (Qty 2) |
| 7 | 19A701312P5 | Flatwasher, M3.5 (Qty 2) |
| 8 | 19A702381P520 | Screw, M3.5 - 0.6 x 20 (Qty 2) |
| 9 | 19A705301P3 | RF Cable Assembly (W1) |
| 10 | Power Cable | (W901 - Part of System Board) |
| 11 | 19A702362P508 | Screws M3.5 - 0.6x8 (Qty 2) |
| 12 | 19A705126P1 | Capacitor Assembly (Z903) |
| 13 | 19D901881G3 | Casting |
| 14 | 19D902132G3 | RF Board (A2) (25 Watt Only) |
| | 19D902132G4 | RF Board (A2) (15 Watt Only) |
| 15 | 19D902151G3 | Logic Board (A1) |
| 16 | 19A705381P506 | Screw, Tapping #6 x 1/2" (Qty 4) |
| 17 | 19D901891G1 | System Board (A5) |
| 18 | 19A705235P1 | Cable Assembly (W3) |
| 19 | 19B801359P3 | Connector (P702) |
| 20 | 19C851442P1 | Cover (Qty 4) |
| 21 | 19A705421P2 | Dust Pad |
| 22 | 19C851573G1 | Bottom Cover |
| 23 | 19A705406P408 | Screw, M4 - 0.7x8 (Qty 2) |
| 24 | 19A701863P17 | Cable Clamp |
| 25 | 19B801398P4 | Microphone |
| 26 | 19B801450P11 | Control Panel (A8) SELECT |
| | 19B801450P12 | Control Panel (A8) SCAN |

MTD 900 MHz MOBILES

PRODUCT CODE MT

MECHANICAL PARTS BREAKDOWN

| ITEM | PART NUMBER | DESCRIPTION |
|------|----------------------|---------------------------------------------|
| 27 | 19D901890P3 | Front Cap (25 Watt Only) |
| | 19D901890P4 | Front Cap (15 Watt Only) |
| 28 | 19A702364P316 | Screw, M3 - 0.5 x 16 (Qty 3) |
| 29 | 19A705165P1 | Loudspeaker (B901) |
| 30 | 19B801459P2 | LCD Assembly (A7) |
| 31 | 19D901889G1 | Shield Can |
| 32 | 19A705234P1 | Cable Assembly (W5) |
| 33 | 19A705234P1 | Cable Assembly (W4) |
| 34 | 19A705421P2 | Foam Pad (Qty 2) |
| 35 | 19A705244P2 | Clip, Spring Tension (Qty 2) |
| 36 | 19A702364P408 | Screw, M3.5 - 0.6x8 |
| 37 | 19D902233G2 | Control Board (A6) (Part of Front Cap Asm) |
| 38 | 19D902304G2 | Audio Board (A3) |
| 39 | 19A705282P1 | Clip |
| 40 | 19A705406P408 | Screw M4-0.7 x 8 (Qty 4) |
| 41 | 19C851586G1 | Mounting Bracket |
| 42 | 19B801358P2 | Battery Cable (Includes Items 47-50) |
| 43 | 19J706152P9 | Cable Tie (Qty 1) |
| 44 | N130P1624B6 | Screw, #10 x 1-1/2, (Qty 6) |
| 45 | N130P1610B6 | Screw, \$10 x 5/8 (Qty 6) |
| 46 | 5490407P6 | Rubber Grommet (Qty 1) |
| 47 | 1R16P5 | Fuse, 2 Amp (Qty 1) |
| | 7102673P2 | Fuse, 15 Amp (Qty 1) |
| 48 | — | Terminal, Crimp, Sim to AMP 34112 |
| 49 | — | Terminal, Crimp, Sim to AMP 34126 (Qty 2) |
| 50 | 19A149451P2 | Fuse Holder (Qty 2) |
| 51 | 19B801467P1 | Cable Assembly (W6) |
| 52 | 19A702364P408 | Screw: M3.5 - 0.6 x 8 |
| 53 | 19A704884P2 | Cable Assembly (W9) |
| — | 19A138051G11 | Mounting Kit (Includes Items 40, 41, 43-46) |

MTD 900 MHz MOBILES

PRODUCT CODE MT

SERVICE ACCESSORIES

RECOMMENDED LIST OF ITEMS

| ORDERING NUMBER | DESCRIPTION |
|--------------------|-----------------------------------------|
| 19A704875P1 | Audio to Logic Board Extender Cable |
| 19B801348P4 | Front Cap to Logic Board Extender Cable |
| TQ0615 | Test Point Adapter Box |

DESCRIPTION OF SERVICING ACCESSORIES



TQ0615 TEST POINT ADAPTER BOX furnishes access to Transmitter and Receiver Audio inputs and Outputs for testing without having to open the radio unit.

MAINTENANCE MANUALS

| BAND | DESCRIPTION | MANUAL # |
|------------|----------------------------|------------------|
| 896-941MHz | Combination Service Manual | LBI-38578 |
| 896-941MHz | Installation Manual | LBI-38572 |
| 896-941MHz | Operators Manual | LBI-38576 |