

EPH SERIES PORTABLE RADIO

Service Manual

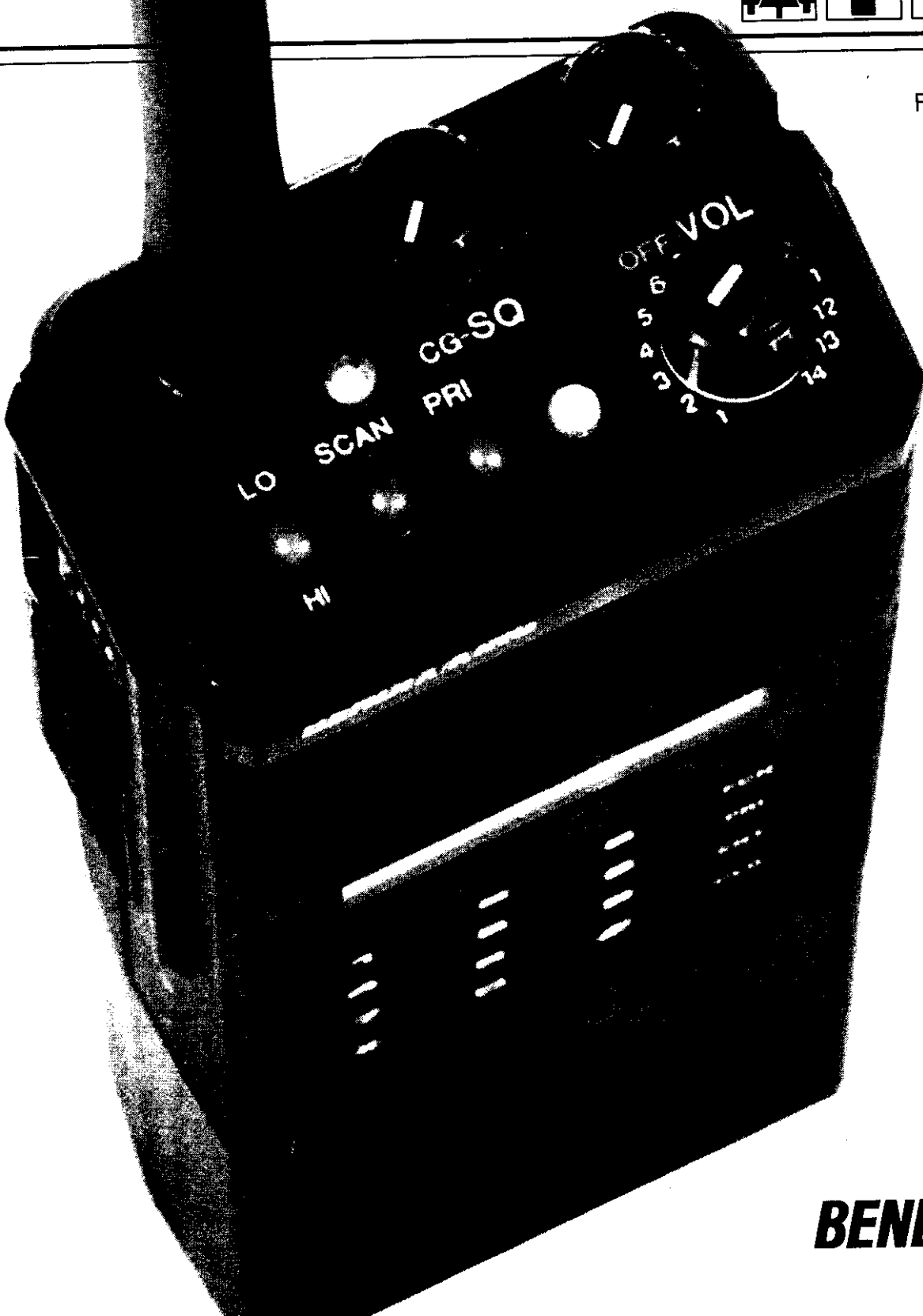

FCC ID: K95GPH51



BENDIX/KING

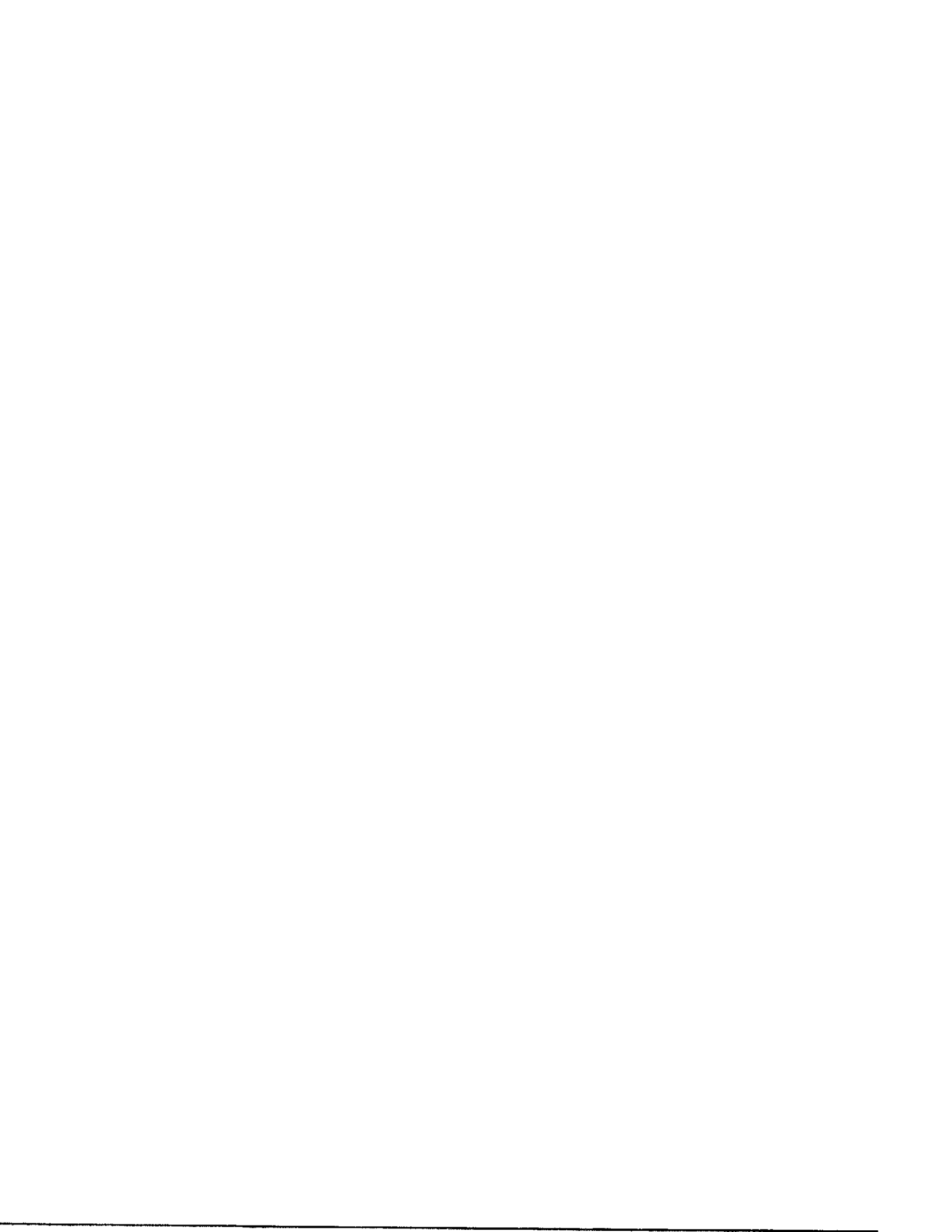

TABLE OF CONTENTS

SECTION I GENERAL INFORMATION

PARAGRAPH		PAGE
1.1	INTRODUCTION	1-1
1.2	INTRINSICALLY SAFE MODELS	1-1
1.3	DESCRIPTION	1-1
1.4	TECHNICAL CHARACTERISTICS	1-2
1.5	ACCESSORIES	1-3
1.6	LICENSE REQUIREMENTS	1-3
1.7	SERVICE INFORMATION	1-3
FIGURE		PAGE
1-1	CONTROLS	1-4

SECTION II INSTALLATION AND PROGRAMMING

PARAGRAPH		PAGE
2.1	GENERAL INFORMATION	2-1
2.2	UNPACKING AND INSPECTING EQUIPMENT	2-1
2.2.1	BATTERY INSTALLATION	2-1
2.3	PROGRAMMING	2-2
2.3.1	ENTER PROGRAMMING MODE	2-2
2.3.2	GENERAL PERFORMANCE VARIABLES (CHANNEL 0)	2-3
2.3.3	CHANNEL 0 GROUP ONE FUNCTIONS	2-5
2.3.4	CHANNEL 0 GROUP TWO FUNCTIONS	2-7
2.3.5	CHANNEL 0 GROUP THREE FUNCTIONS (ALPHANUMERIC DISPLAY ONLY)	2-8
2.3.6	ALPHANUMERIC DISPLAY FUNCTIONS	2-10
2.3.7	REVIEW CHANNEL 0 VALUES	2-11
2.3.8	ENTER CHANNEL FREQUENCIES AND CODE GUARD VALUES	2-12
2.3.9	LEAVE THE PROGRAMMING MODE	2-14
2.4	GROUP SELECTION	2-14
2.5	CLONING RADIO SETTINGS	2-15
2.5.1	GROUP CLONING	2-16
2.5.2	SPECIAL CLONING INSTRUCTIONS	2-16
2.5.3	SCAN LIST AND PRIORITY CHANNEL CLONING	2-17
2.6	PROGRAMMING BY COMPUTER	2-17
2.7	TONE CODE GUARD VALUES	2-18
2.8	DIGITAL CODE GUARD VALUES	2-18
FIGURE		PAGE
2-1	BATTERY INSTALLATION	2-1

SECTION III
OPERATION

PARAGRAPH		PAGE
3.1	INTRODUCTION	3-1
3.1.1	DISPLAY OPTIONS	3-1
3.2	OPERATION	3-2
3.2.1	BASIC OPERATION	3-2
3.2.2	CODE GUARD OPERATION	3-3
3.2.3	HI/LO TRANSMIT POWER	3-3
3.2.4	BUILT-IN FEATURES	3-3
3.2.5	OPERATIONAL FEATURES AVAILABLE	3-4
3.2.6	GROUP OPERATION	3-11

FIGURE		PAGE
3-1	LIQUID CRYSTAL DISPLAYS	3-1

SECTION IV
THEORY OF OPERATION

PARAGRAPH		PAGE
4.1	INTRODUCTION	4-1
4.2	EQUIPMENT DESCRIPTION	4-1
4.3	THEORY OF OPERATION	4-1
4.3.1	RECEIVER	4-1
4.3.2	TRANSMITTER	4-3
4.3.3	SYNTHESIZER	4-5
4.3.4	SYSTEMS AREA	4-7

FIGURE		PAGE
4-1	RECEIVER BLOCK DIAGRAM	4-2
4-2	TRANSMITTER BLOCK DIAGRAM	4-3
4-3	POWER AMPLIFIER BLOCK DIAGRAM	4-3
4-4	ANTENNA SWITCH FUNCTIONAL BLOCK DIAGRAM	4-4
4-5	SYNTHESIZER BLOCK DIAGRAM	4-5

SECTION V MAINTENANCE

PARAGRAPH		PAGE
5.1	INTRODUCTION	5-1
5.2	TEST EQUIPMENT REQUIRED	5-1
5.3	OVERHAUL	5-2
5.3.1	VISUAL INSPECTION	5-2
5.3.2	CLEANING	5-4
5.3.3	REPAIR	5-4
5.4	DISASSEMBLY/ASSEMBLY	5-5
5.4.1	BATTERY REMOVAL	5-5
5.4.2	UNIT DISASSEMBLY	5-5
5.4.3	ASSEMBLY	5-5
5.5	TEST AND ALIGNMENT PROCEDURES	5-6
5.5.1	TEST SET-UP	5-6
5.5.2	SYNTHESIZER	5-6
5.5.3	TRANSMITTER	5-7
5.5.4	RECEIVER	5-9
5.6	TROUBLESHOOTING	5-11
FIGURE		PAGE
5-1	REFERENCE MODULATION ADJUSTMENT	5-7
5-2	TRANSMITTER TEST SET-UP	5-8
5-3	RECEIVER TEST SET-UP	5-10
TABLE		PAGE
5-1	TROUBLESHOOTING	5-11

SECTION VI
ILLUSTRATED PARTS LIST

PARAGRAPH	PAGE
6.1 INTRODUCTION	6-1
6.2 BILLS OF MATERIAL	6-1
FINAL ASSEMBLY	6-3
SYSTEMS FRAME ASSEMBLY	6-9
CONTROL BOARD	6-15
SYSTEMS BOARD	6-19
TOP FRAME ASSEMBLY	6-29
RX/TX FRAME ASSEMBLY	6-33
2 WATT RX/TX BOARD	6-37
5 WATT RX/TX BOARD	6-43
FRONT COVER ASSEMBLY	6-49
OPTIONS BOARD	6-53
KEYBOARD/DISPLAY ASSEMBLY	6-59
KEYBOARD/DISPLAY BOARD	6-65
ALPHANUMERIC DISPLAY BOARD	6-69

SUPPLEMENTS

APPENDIX	PAGE
A INTEGRATED CIRCUIT DATA	A-1

SECTION I GENERAL INFORMATION

1.1 INTRODUCTION

This manual contains information concerning the physical, mechanical, and electrical characteristics of the Bendix/King EPH Series handheld VHF radios.

1.2 INTRINSICALLY SAFE MODELS

Radios certified Intrinsically Safe for use in hazardous environments require special care in their repair and maintenance. Therefore, it is strongly recommended that you send all Intrinsically Safe radios in need of repair to the Bendix/King factory to ensure compliance with Intrinsically Safe certification.

WARNING
MODIFICATION OR IMPROPER REPAIR OF INTRINSICALLY SAFE RADIOS
WILL MAKE THEM UNSAFE FOR OPERATION IN HAZARDOUS
ENVIRONMENTS AND WILL VOID THEIR INTRINSICALLY SAFE RATING.

1.3 DESCRIPTION

The EPH Series radios are self-contained VHF FM Transceivers covering the frequency range of 148MHz to 174MHz. The units are multi-channel, digitally synthesized radios using a single crystal for frequency control. All models incorporate an EEPROM for the storage of channel frequency, Code Guard™, and Dual Tone Multiple Frequency/Automatic Numeric Identifier (DTMF/ANI) encode information. All models also include low battery and busy channel indicators. Toggle switches control hi/low transmit power, priority scan, and multi-channel scan. Status and channel information is displayed over a liquid crystal display on Keyboard/Display models. Connectors are provided on the side of the unit for external antenna, microphone, speaker, and other optional accessories. A variety of twist-off battery packs are also available.

A partial list of EPH models and unit features appear in the table below:

EPH MODEL	CHANNELS/ SYSTEM	KEYBOARD DISPLAY	SPECIAL FEATURES
214 2A	14	Alphanumeric	2 Watt
514 0A	14	none	
514 0M	14	none	Metal Case
514 1A	14	Standard	
514 2A	14	Alphanumeric	
514 2M	14	Alphanumeric	Metal Case
599 1A	System	Standard	
599 2A	System	Alphanumeric	

NOTE: System radios may have special programming features that reduce the number of channels available to the user. Depending on the model, System radios may have as many as 210 channels, or as few as 14 channels.

1.4 TECHNICAL CHARACTERISTICS

FREQUENCY:	148-174MHz
POWER SUPPLY:	One rechargeable nickel-cadmium battery pack with temperature sensor or one Alkaline battery pack
OPERATIONAL FEATURES:	Programmable (Keyboard units only)
Priority Channel Scan	Programmable
Transmit-Time-Out Timer	Programmable
Scan Delay	Programmable
DTMF/ANI Encode	Programmable
Code Guard Squelch	Programmable
Squelch Tail Elimination	Standard
CHANNELS:	
EPH 214/514	14
EPH 599	210 in fifteen 14-channel groups
FREQUENCY SPREAD:	26 MHz with no degradation
OPERATING TEMPERATURE:	-30° to +60°c

PHYSICAL DIMENSIONS

Weight:	20 oz. (24 oz. with large battery) 0.6 kilograms (0.7 Kg with large battery)
Width:	2.55 in. (64.8 millimeters)
Depth:	1.5 in. (38.1 mm.)
Height:	6.6 in. (167.6 mm.) 7.8 in. (198.1 mm.) with large battery
ANTENNA TYPE:	Threaded Helical wound rubber flex (standard) BNC Helical wound rubber flex (optional)
CHANNEL SPACING:	30 Khz
MAX CURRENT DRAIN:	
Transmit 5 watt:	1.4 amps
Receive:	165 mA
Receive standby:	45 mA (battery save off) 15 mA (battery save on)
FCC Identification number:	ASY90Q LT20001

TRANSMITTER

RF OUTPUT POWER:	5 Watts (HI Power Mode)* 2 Watts (LO Power Mode)* 2 Watts EPH 214
------------------	---

*High and Low power output are computer programmable

MODULATION CHARACTERISTICS:	15KOF2D 16KOF3E 16KOFXE
SPURIOUS AND HARMONICS:	60 dB
MAXIMUM DEVIATION:	5 Khz

FM HUM AND NOISE (EIA):	43 dB
FREQUENCY STABILITY:	±5 PPM
AUDIO DISTORTION:	3% maximum with 3KHz deviation
AUDIO RESPONSE:	+1 to -3dB from 6dB/octave pre-emphasis at 0.3 to 3 KHz
DUTY CYCLE:	5 - 5 - 90%

RECEIVER

SENSITIVITY: 12dB SINAD	0.25 μ V
NOISE SQUELCH:	0.18 μ V
SELECTIVITY:	70 dB
IMAGE AND SPURIOUS RESPONSES:	75dB
INTERMODULATION:	70dB
AUDIO RESPONSE:	+1dB to -3dB from 6dB/octave de-emphasis at 0.3 to 3KHz
AUDIO OUTPUT:	500mW with 5% maximum distortion into an 8 ohm load

1.5 ACCESSORIES

A wide variety of optional accessories are available for the EPH hand held transceivers. Contact your BENDIX/KING dealer for complete information.

1.6 LICENSE REQUIREMENTS

This equipment must be licensed by the Federal Communications Commission (FCC) before it may be used. Your BENDIX/KING dealer can assist you in filing the appropriate application for the FCC, and will program each radio with your authorized frequencies and signaling codes.

1.7 SERVICE INFORMATION

If you need service, contact your BENDIX/KING dealer. He or any BENDIX/KING Mobile Communications dealer is equipped to service your radio.

If you find it inconvenient to have service performed by your local dealer, you may contact the factory at this address:

BENDIX/KING
 Mobile Communications Division
 2920 Haskell Avenue
 Lawrence, Kansas 66046
 (913) 842-0402

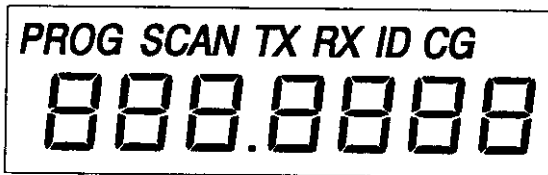
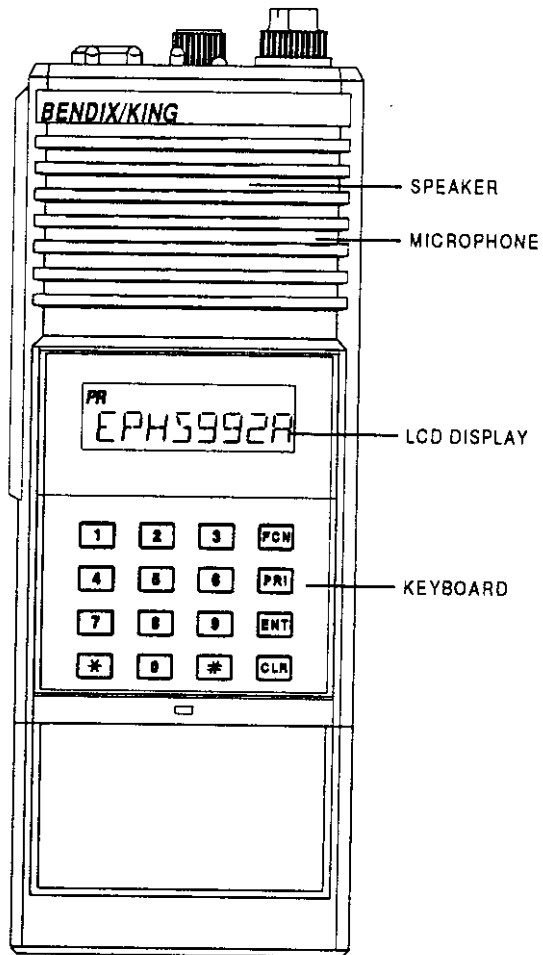
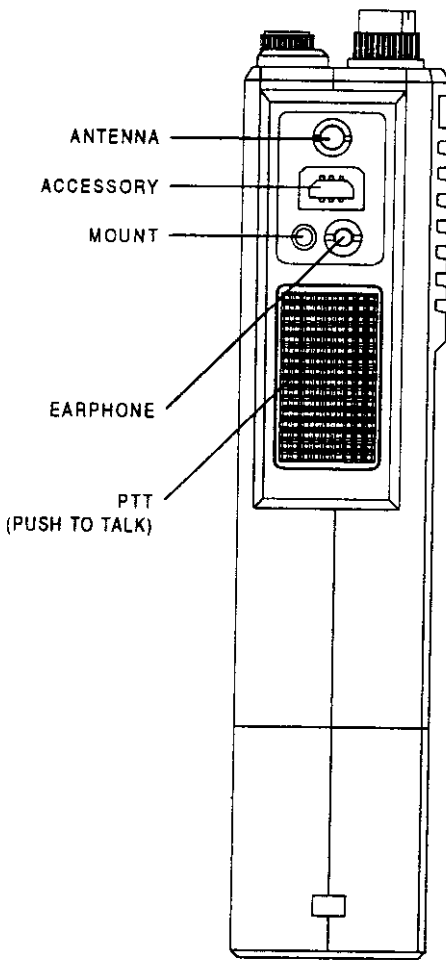
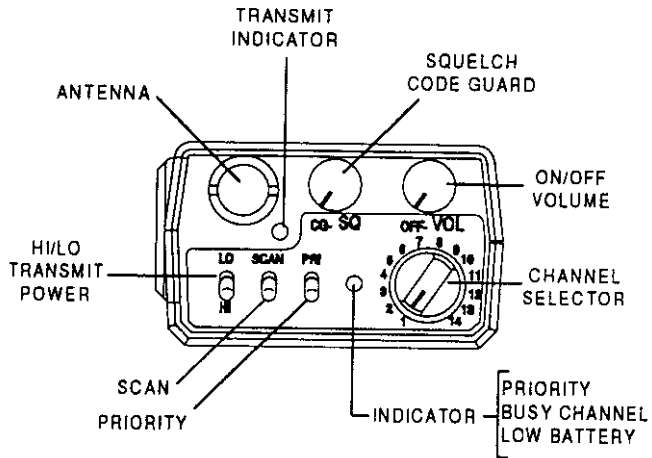
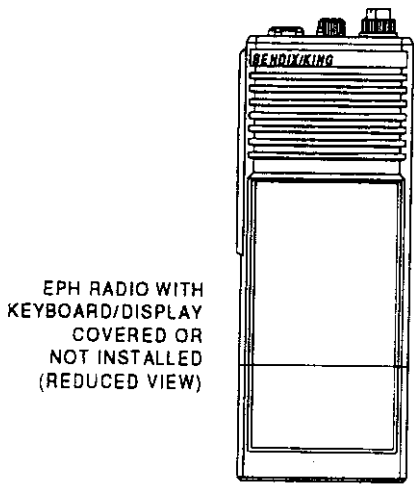

7-SEGMENT DISPLAY



ALPHANUMERIC DISPLAY

FIGURE 1-1 CONTROLS

SECTION II INSTALLATION AND PROGRAMMING

2.1 GENERAL INFORMATION

This section contains information concerning the installation and programming of Bendix/King EPH Series handheld VHF radios.

2.2 UNPACKING AND INSPECTING EQUIPMENT

Exercise extreme care when unpacking the equipment. Make a visual inspection of the unit for evidence of damage incurred during shipment. If a claim for damage is to be made, save the shipping container to substantiate the claim. The claim should be promptly filed with the transportation company. It would be advisable to retain the container and packaging material after all equipment has been removed in the event that equipment storage or reshipment should become necessary.

2.2.1 BATTERY INSTALLATION

- A. Bendix/King battery packs are available in a variety of sizes and types for special applications. Rechargeable battery packs can be charged separately or while attached to a radio.
- B. To install the battery, locate the center hub on the radio base and place it in the recess of the battery pack. Position the pack at the 30° offset, seating two metal studs in their recess. Apply upward pressure to the pack while twisting the pack to its original position. The metal tab will click, locking the pack in position.
- C. To remove the battery, turn the radio off. Press up the metal tab on the side of the case while twisting the battery pack approximately 30° and remove it from the radio.
- D. Periodically check the contacts on battery pack for dirt that may prevent a good electrical contact with the charging base.

WARNING

DO NOT DISPOSE OF A
BATTERY PACK IN FIRE.
AN EXPLOSION MAY OCCUR.

WARNING

FOR INTRINSICALLY SAFE RADIOS
DESIGNED FOR USE IN HAZARDOUS
ENVIRONMENTS, REPLACEMENT
BATTERIES MUST BE APPROVED BY
FACTORY MUTUAL RESEARCH FOR
USE WITH BENDIX/KING RADIOS.

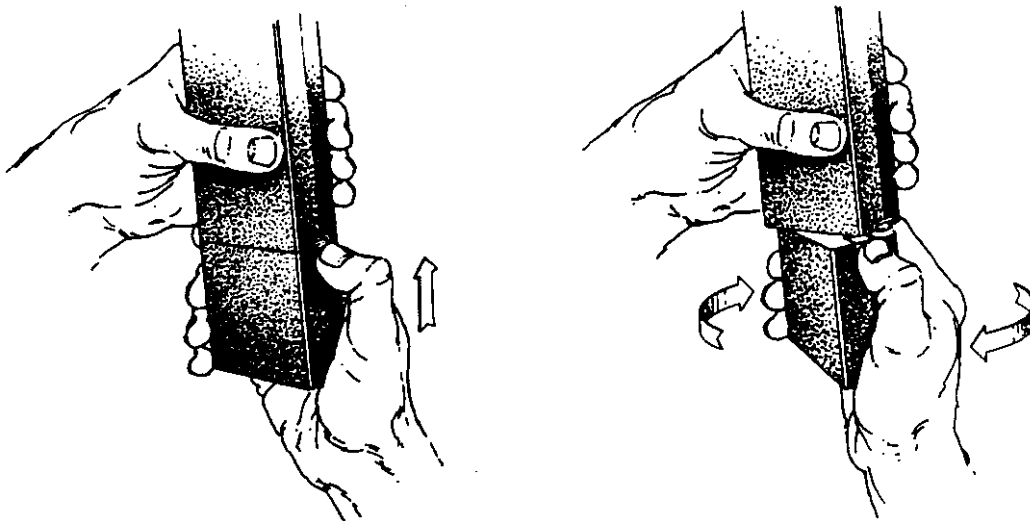

FIGURE 2-1 BATTERY INSTALLATION

2.3 PROGRAMMING

Bendix/King offers two basic types of EPH handheld radios. The first type has a keyboard and liquid crystal display (LCD). The second type has no keyboard or display.

There are three different ways to program these radios:

- A. A radio with a keyboard and display can be programmed by using its keyboard and a programming plug. This section of the manual describes that procedure.
- B. A radio with a keyboard and display can transfer its programmed settings (except Alphanumeric display settings) to another radio of the same frequency band, by using a cloning cable. See "Cloning Radio Settings" on page 2-15.
- C. Any Bendix/King handheld radio can be programmed from a computer by using a special RS-232 interface cable. That procedure is not described in this manual. Contact Bendix/King for the programming cable, software, and instruction manual.

2.3.1 ENTER PROGRAMMING MODE

Radios are shipped with a door covering the keyboard and display. Before programming, remove the door by removing the battery pack, engaging the door just below the speaker grill, and sliding the door downward. Replace the battery pack.

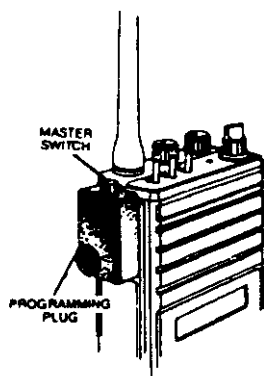

1. Make sure the battery pack is charged.
2. Insert the programming plug into the side connector of the radio. The pushbutton master switch will be on top.

NOTE: The cloning cable may be used as a substitute for the programming plug by inserting the end with the pushbutton master switch into the side connector of the radio.

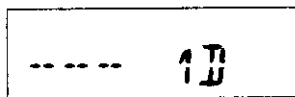

3. Select a channel group to be programmed. (Not necessary in 14-channel radios.) See "Group Selection" on page 2-14.
4. Press and hold the master switch.
5. While holding the master switch, press and hold the [FCN] key. After approximately three seconds the LCD will display - - - ID.
6. Release the [FCN] key and the master switch. The radio is now in the password entry mode.
7. Enter the six-digit password code. Without the correct password code, you cannot proceed with programming.

NOTE: New radios shipped from the factory are assigned the password code 000000.

While entering the password code the display will not change, but a beep will sound for each key pressed. If the password code is entered incorrectly, the radio will reset to normal operation. Try again, starting at step 4.

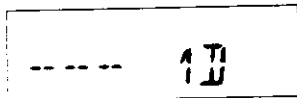

- To keep the password unchanged, press the [ENT] key and continue with normal radio programming.

To change the password, press the [FCN] key and enter a new six-digit password code. The digits are displayed as you enter them.

NOTE: Do not use a 1 for the first digit of the password code - the radio will malfunction. The password code can contain the digits 0 through 9, *, and #.

If you make an error entering the new password code, press the [CLR] key and try again.

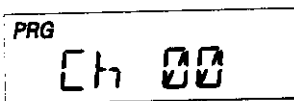

- Press the [ENT] key to store the new password and proceed to programming mode. The display will change to PRG Ch 00 (Alphanumeric display) or PROG Ch 0 (standard 7-Segment display).

2.3.2 GENERAL PERFORMANCE VARIABLES (CHANNEL 0)

Channel 0 is the portion of the program that controls general performance variables for all the channels in a 14-channel radio. For a 210-channel radio, the Channel 0 settings for each group must be programmed separately. Select the group to be programmed before entering Programming Mode. See "Group Selection" on page 2-14.

The same password code is used for all groups in the radio.

NOTE: Settings listed as Group One functions, Group Two functions, and Group Three functions refer to programming function groups, not channel groups.

Press the [FCN] key repeatedly to view the settings in Channel 0, then loop back to the Ch 00 entry point. Channel 0 settings include:

Automatic Number Identification (ANI)

Transmitter Timeout Timer

Scan Delay Time

Group One functions: 1-12345

Battery Saver

Priority Scan Operation

Priority Key Lockout

Scan List Lockout

Group Two functions: 2-12345

Enable User Code Guard

Busy Channel Operation

ANI Enable

DTMF Enable

Group Three functions: 3-12345

Backlight Enable Conditions

Alphanumeric Mode Enable

Backlight Duration

Group Label

(Alphanumeric Display only)

(Alphanumeric Display only)

(Alphanumeric Display only)

(Alphanumeric Display only)

(Alphanumeric Display only)

NOTE: Illustrations in this section show an Alphanumeric Display. The same procedures are also used to program radios with standard 7-Segment displays, except that some procedures apply only to Alphanumeric Displays (see below).

A. AUTOMATIC NUMBER IDENTIFICATION (ANI)

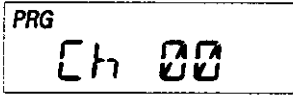

1. After entering the programming mode the LCD will display **PRG Ch 00** (Alphanumeric) or **PROG CH 0** (7-Segment).

2. Press the **[FCN]** key.

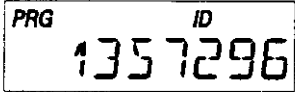

3. The display will indicate the ANI ID number (as many as seven digits may be used). The ID number can be used for either radio management or transmitted as a DTMF tone burst for ANI purposes. The ANI can be enabled or disabled. See "ANI ENABLE" on page 2-8.

4a. If no change is needed for the ID number, press the **[FCN]** key to advance to the next section.

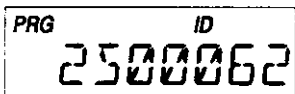

4b. A new number can be entered by pressing the **[CLR]** key, followed by number keys. The digits will appear to right of the display and move to the left.



4c. The existing ID number can be incremented one digit by pressing **[PRI]**.

4d. Press the **[ENT]** key to store the new ID number and advance to the next section.

If the new ID number will be used only for cloning, press **[FCN]** instead of **[ENT]** to advance to the next section. The ID number will not be stored locally.

B. TRANSMITTER TIME OUT TIMER

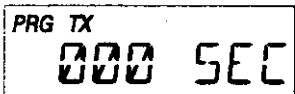

After the ID number is set, the display annunciator will indicate **PRG TX**. This is the duration of the transmitter Time Out Timer. **0 SEC** means the Time Out Timer is disabled.

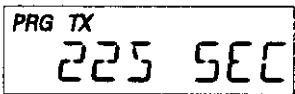

Press the **[PRI]** key to increase the Time Out Timer duration by 15 seconds, with a maximum of 225 seconds (3 minutes, 45 seconds). Press the **[PRI]** key again to change the duration from 225 seconds to zero.

Press the **[CLR]** key to set the Time Out Timer duration to zero.

Press the **[ENT]** key to store the changed setting and advance to the next section.

Press the **[FCN]** key to advance to the next section if no change is needed, or if a new setting is only to be cloned, not stored locally.

C. SCAN DELAY TIME

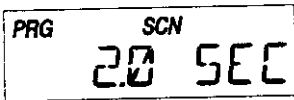

After the Time Out Timer is set, the upper display will indicate **PRG SCN**. This is the scan delay time in seconds.

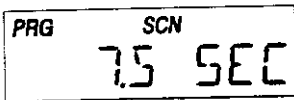

Press the **[PRI]** key to increase the scan delay time by .5 seconds, up to 7.5 seconds. Press the **[PRI]** key again to change the time from 7.5 seconds to 0.

Press the **[CLR]** key to reset the scan delay time to 0.

Press the **[ENT]** key to store the changed setting and advance to the next section.

Press the **[FCN]** key to advance to the next section if no change is needed, or if a new setting is only to be cloned, not stored locally.

2.3.3 CHANNEL 0 GROUP ONE FUNCTIONS

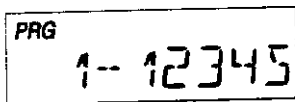

After the scan delay time is set the LCD will display **PRG 1-12345**. This is a group of five individual functions that can be enabled or disabled.

When a function is enabled, the corresponding number in the display will flash. When the function is disabled the number is steady. If you wish to change the function from enable to disable or vice versa, press the number key corresponding to that function.

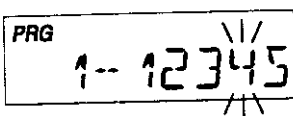

EXAMPLE: If function 4 (Priority Key Lockout) is disabled, the 4 in the display will not be flashing. If the **[4]** key is pressed, the 4 in the display will flash, signifying that Priority Key Lockout is enabled. A subsequent press of the **[4]** key will disable Priority Key Lockout.

A. BATTERY SAVER INHIBIT



When function 1 is enabled (flashing) the battery saver is turned off. The battery saver should be turned off only to get proper voltage readings during service or in systems requiring extremely fast squelch attack time.

NOTE: Bendix/King current drain and battery life specifications are based on performance with the battery saver on.

B. PRIORITY SCAN

Functions 2 and 3 are used to define Priority Scan operation. There are three types of Priority Scan available. They are described in greater detail under "Priority Operation" beginning on page 3-5. Priority Scan modes include:

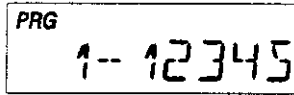

Priority Mode A - The Priority Channel follows the position of the Channel Selector knob.



Priority Mode B - The Priority Channel is fixed. You will transmit on the channel selected by the Channel Selector knob.

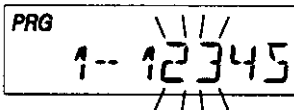

Priority Mode C - The Priority Channel is fixed. When the PRI toggle switch is on, you will transmit on the Priority Channel regardless of the Channel Selector knob setting.

To set Function 2 and 3 for Priority Mode A, B, or C, use the following chart:

	FUNCTION 2	FUNCTION 3
PRIORITY MODE A	DISABLE (STEADY)	DISABLE (STEADY)
PRIORITY MODE B	ENABLE (FLASHING)	DISABLE (STEADY)
PRIORITY MODE C	ENABLE (FLASHING)	ENABLE (FLASHING)

C. PRI KEY LOCKOUT

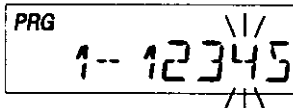

When function 4 is enabled (flashing) the [PRI] key is locked out in the operating mode. The user will not be able to change the designation of the Priority Channel.

When function 4 is disabled (steady) the user will be able to change the channel that is designated as Priority Channel. See "Changing the Priority Channel" on page 3-8.

D. SCAN LIST LOCKOUT

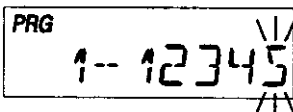

When function 5 is enabled (flashing), the user will not be able to change the channels in the scan list. When disabled (steady), the user can enter or delete channels from the scan list. See "Changing the Scan List" on page 3-5.

E. STORE GROUP ONE SETTINGS

Once each function 1-5 is set as desired, you can store the changes, discard the changes, or disable all 5 functions.

Press the [CLR] key to disable all Group One functions (steady).

Press the [ENT] key to store new Group One settings into memory and advance to the next section.

Press the [FCN] key to advance to the next section without saving changes or if the new settings are only to be cloned, not stored locally.

2.3.4 CHANNEL 0 GROUP TWO FUNCTIONS

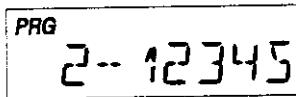

After Group One functions are set, the LCD will display PRG 2-12345 for Group Two functions. As with Group One functions, the enabled function number will flash. The disabled functions remain steady.

A. USER CODE GUARD SELECTION

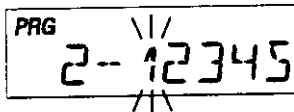

When function 1 is enabled (flashing) the user will be able to press the keyboard to independently select the Code Guard values that are programmed into Channels 1 thru 9 while operating on any Channel 1 thru 14. When disabled the user will be unable to use the keyboard for Code Guard selection. See "User Code Guard Selection" on page 3-8.

B. BUSY CHANNEL OPERATION

Functions two and three are used to set Busy Channel operation. There are three types of busy channel operation available. They are described more fully under "Busy Channel Indication" on page 3-9. Busy Channel modes include:

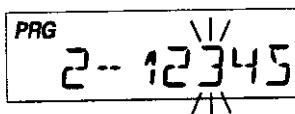

Busy Channel Indicator - The yellow LED illuminates when a signal is received on the channel selected, with or without the programmed receive Code Guard setting.

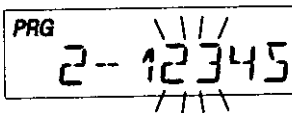

Busy Channel Lockout - The yellow LED illuminates and the transmitter PTT is disabled when a signal is received without the programmed receive Code Guard setting.

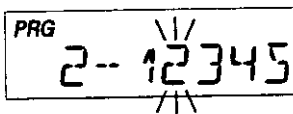

Busy Channel Override - This function is similar to Busy Channel Lockout except the transmitter PTT can be activated by rotating the Squelch knob clockwise off the Code Guard detent.

To set Busy Channel operation use the following chart:

	FUNCTION 2	FUNCTION 3
BUSY CHANNEL INDICATION	DISABLE (STEADY)	ENABLE (FLASHING)
BUSY CHANNEL LOCKOUT	ENABLE (FLASHING)	ENABLE (FLASHING)
BUSY CHANNEL OVERRIDE	ENABLE (FLASHING)	DISABLE (STEADY)

C. ANI ENABLE

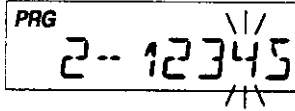

When function 4 is enabled (flashing) the ANI ID number will be transmitted (as a DTMF tone sequence) with each press of the PTT switch. See "Automatic Number Identification (ANI)" on page 2-4 for instructions on setting the ANI number..

When functions 4 and 5 are both enabled (flashing) the ANI tone sequence will be transmitted only after the [ENT] key is pressed while the transmit PTT switch is activated. A sidetone of the ANI number transmitted will also be heard through the speaker.

D. DTMF ENABLE

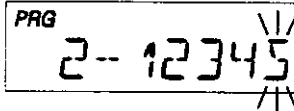

When function 5 is enabled (flashing) the keypad becomes active for manual DTMF operation.

E. STORE GROUP TWO SETTINGS

Once Group Two functions are set, press the [ENT] key to store them into memory and automatically advance the program to the next section. Alphanumeric displays advance to Group Three settings. Standard 7-Segment displays go back to the starting point for Channel 0 settings.

Once each function 1-5 is set as desired, you can store the changes, discard the changes, or disable all 5 functions.

Press the [CLR] key to disable all Group Two functions (steady).

Press the [ENT] key to store new Group Two settings into memory and advance to the next section.

Press the [FCN] key to advance to the next section without saving changes or if the new settings are only to be cloned, not stored locally.

NOTE: If programmed settings are to be cloned (not stored locally) proceed with the cloning procedure before advancing to the next section. Otherwise, these settings will be lost. See "Cloning Radio Settings" on page 2-15.

NOTE: Group Three settings, Alphanumeric display functions, group labels, and channel labels cannot be transferred by cloning.

2.3.5 CHANNEL 0 GROUP THREE FUNCTIONS (ALPHANUMERIC DISPLAY ONLY)

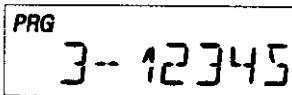

After Group Two functions are set, the LCD will display PRG 3-12345 for Group Three functions. As with Group One and Group Two functions, the enabled function number will flash. The disabled functions remain steady.

Group three functions are available only with Alphanumeric displays.

A. BACKLIGHT ON MAIN CHANNEL ACTIVITY

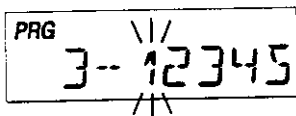

When function 1 is enabled (flashing) the LCD backlight will illuminate each time the display receives input related to the main channel. This includes displayed changes in the selected channel and the PR, TX, and SCN annunciators.

The LCD will not illuminate if backlight duration is set to LITE OFF. See "Backlight Duration" on page 2-10.

B. BACKLIGHT ON SCAN CHANNEL ACTIVITY

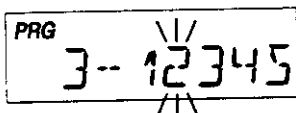

When function 2 is enabled (flashing) the LCD backlight will illuminate each time the display receives input related to the scan channel. This includes displaying the scan channel and the CG annunciator.

The LCD will not illuminate if backlight duration is set to LITE OFF. See "Backlight Duration" on page 2-10.

C. BACKLIGHT ON OTHER DISPLAY ACTIVITY

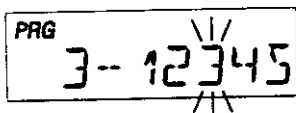

When function 3 is enabled (flashing) the LCD backlight will illuminate each time the display receives input not related to the main or scan channel. This is not used often, but includes the ---ld prompt for password input.

The LCD will not illuminate if backlight duration is set to LITE OFF. See "Backlight Duration" on page 2-10.

D. BACKLIGHT ON KEY PRESS

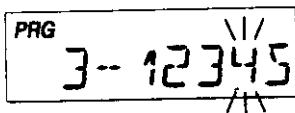

When function 4 is enabled (flashing) the LCD backlight will illuminate each time a key is pressed on the keypad, even if pressing the key has no other effect.

The LCD will not illuminate if backlight duration is set to LITE OFF. See "Backlight Duration" on page 2-10.

E. ALPHANUMERIC MODE

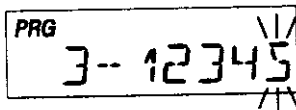

When function 5 is enabled (flashing) the LCD operates in Alphanumeric mode, enabling display of channel labels. When disabled (steady) the LCD operates in standard (7-segment) display mode. This disables display of channel labels.

F. STORE GROUP THREE SETTINGS

Once each function 1-5 is set as desired, you can store the changes, discard the changes, or disable all 5 functions.

Press the [CLR] key to disable all Group Three functions (steady).

Press the [ENT] key to store new Group Three settings into memory and advance to the next section.

Press the [FCN] key to advance to the next section without saving changes.

2.3.6 ALPHANUMERIC DISPLAY FUNCTIONS (ALPHANUMERIC DISPLAY ONLY)

The following Display Functions are available only with Alphanumeric displays.

A. BACKLIGHT DURATION

PRG
1 SEC ON

After Group Three functions, the LCD displays the current backlight duration setting. Available settings are LITE OFF, 1 SEC ON, one second increments up to 6 SEC ON, and LITE ON.

If no change is needed, press the [FCN] key to advance to the next section.

PRG
LITE OFF

Press the [CLR] key to set backlight duration to zero and display LITE OFF.

PRG
6 SEC ON

Press the [PRI] key to increase backlight duration by 1 second increments from LITE OFF, to 1 SEC ON, 2, 3, 4, 5, 6 SEC ON, LITE ON (illumination remains on constantly) then back to LITE OFF.

NOTE: The backlight illuminates for the duration of the new setting. For example, if you press the [PRI] key to change the setting from 2 SEC ON to 3 SEC ON the backlight immediately illuminates for three seconds.

PRG
LITE ON

NOTE: Excessive battery drain will result if LITE ON is set and used for extended periods of time.

Press the [ENT] key to store changes and advance to the next function.

Press the [FCN] key to advance to the next function without storing changes.

B. GROUP LABEL

TACTICAL

After the Backlight Duration setting, the LCD displays the current label for the channel group. Each channel group can have a label of up to eight characters or spaces. The characters can include 0 - 9, A - Z, -, *, \$, /, +, %, \, |, _, <, >, h, or blank.

- If no change is needed, press the [FCN] key to go back to the starting point for Channel 0 settings.
- Press the [CLR] key to erase the current label.
- Press the [CLR] key a second time to restore the current label.

NOTE: Special software available from Bendix/King enables entering group labels and channel labels from a computer. Contact Bendix/King for the programming cable, software, and instruction manual.

CHANGE THE LABEL

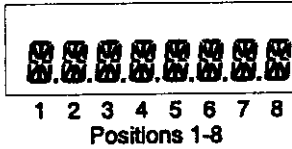

- 1 Press the **[CLR]** key. The display becomes blank.
- 2 Press number keys to enter 0 - 9 in positions one through seven. The digits start in position seven, then move left.
- 3 Press the **[#]** key to toggle a decimal on or off to the right of the character in position seven. The decimal moves left with the number in position seven as new numbers are entered.
- 4 Use the following steps to enter a number in position eight, or characters in positions one through eight:

LABEL WITH LETTERS, NUMBERS, ETC.

- 1 Press the **[PRI]** key repeatedly to cycle through characters 0 - 9, A - Z, -, *, \$, /, +, %, \, |, _, <, >, h, blank, then back to the start again.

If you pass the desired character, press the **[PRI]** key repeatedly until you return to the start and reach that character again.

- 2 Press the **[FCN]** key to shift the display left by one position, leaving position eight blank.
- 3 Press the **[PRI]** key repeatedly to enter the next character, or press the **[FCN]** key a second time to enter a blank space.
- 4 To abandon changes, press the **[CLR]** key, restoring the original label.
- 5 Press the **[ENT]** key to store changes and go back to the starting point for Channel 0 settings.

2.3.7 REVIEW CHANNEL 0 VALUES

Press the **[FCN]** key repeatedly to display each value in Channel 0, then return to the Channel 0 starting point.

2.3.8 ENTER CHANNEL FREQUENCIES AND CODE GUARD VALUES

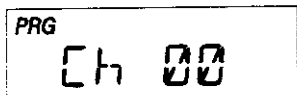

At the starting point for Channel 0, the LCD will display PRG Ch 00. At this point, a channel number can now be pressed to allow access to the frequency and Code Guard values for that channel.

NOTE: A valid receive frequency must be programmed into each channel intended for use. If a 0 value or an invalid frequency is programmed, the LCD will give a false reading in the operation mode, and may result in radio malfunction. If a malfunction occurs, reset the radio by turning it off and then back on.

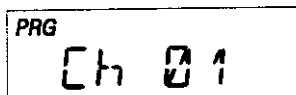

1. Press 1 and the LCD will display PRG CH 01. This is the starting point for entering channel 1 values.

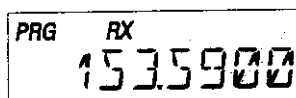

2. Press the [FCN] key and the upper part of the LCD will display PRG RX. This is the receive frequency for channel 1 (in MHz).

3. If the displayed frequency is correct, press the [FCN] key to advance to the next value.

If a new frequency is desired, press the [CLR] key followed by the digits of the desired frequency. Then press the [ENT] key to store this frequency and automatically advance to the next value.

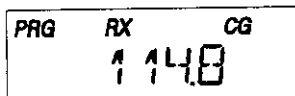

4. After the receive frequency is set, the upper part of the LCD will display PRG RX CG. This is the Code Guard value for Channel 1 receive.

NOTE: 0.0 indicates carrier squelch operation (no Code Guard).

If the displayed value is correct, press the [FCN] key to advance to the next value.



If a new value is desired, press the [CLR] key to reset the display to 0.0. Press the number keys 0 thru 9 to enter a Tone Code Guard value. See "Tone Code Guard Values" on page 2-18.

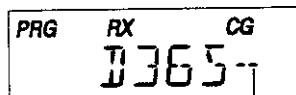

INDICATES INVERTED CODE

To enter a Digital Code Guard value press the [#] key, causing the letter D to appear followed by three zeros. Enter the desired digital code using keys 0 thru 7 (keys 8 & 9 do not respond). See "Digital Code Guard Values" on page 2-18. Pressing the [PRI] key after the three-digit code has been entered allows the digital code to be inverted. When the displayed value is correct, press the [ENT] key to store the Code Guard value and automatically advance to the next value.

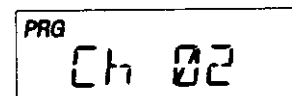
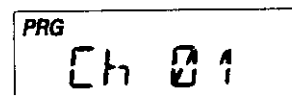
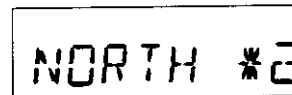
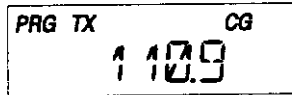
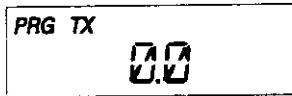
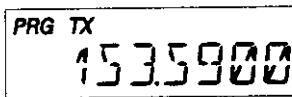

5. After the receive Code Guard is set the upper part of the LCD will display **PRG TX**. This is the transmitter frequency for Channel 1. If it is correct, press the **[FCN]** key to advance to the next value.

If you wish to change it, press the **[CLR]** key followed by the frequency in MHz then **[ENT]** to store the new frequency and automatically advance to the next value.

Only valid frequencies will be operable.

6. After the transmit frequency is set the upper part of the LCD will display **PRG TX CG**. This is the Code Guard value for Channel 1 transmit (0.0 indicates carrier squelch). If this value is correct press the **[FCN]** key to advance to the next value.

To enter a new value, press the **[CLR]** key to reset the display to 0.0. Press the number keys to enter a Tone Code Guard value. See "Tone Code Guard Values" on page 2-18.

To enter Digital Code Guard, first press the **[CLR]** key, then the **[#]** key, causing the letter **D** to appear followed by three zeros. Enter the desired digital code using keys 0 thru 7 (keys 8 & 9 do not respond). See "Digital Code Guard Values" on page 2-18. Pressing the **[PRI]** key after the three digit code has been entered allows the digital code to be inverted. When the displayed value is correct, press the **[ENT]** key to store the Code Guard and automatically advance to the next value.

7. After the transmit Code Guard is set, the LCD will display the channel label. If this label is correct press the **[FCN]** key to proceed to the entry point.

If a new channel label is desired, follow the instructions under "Change the Label" on page 2-11.

8. After the channel label is set, the display will return to the Channel 1 starting point. If you wish to review the frequencies and Code Guard values in Channel 1, subsequent pressing of the **[FCN]** key will show each value and then return to the Channel 1 starting point.

9. At the starting point for Channel 1, the display will show **PRG CH 01**. Press the number keys for another channel number to gain access to the frequencies and Code Guard values for that channel. Each channel is then programmed using the same steps described for Channel 1.

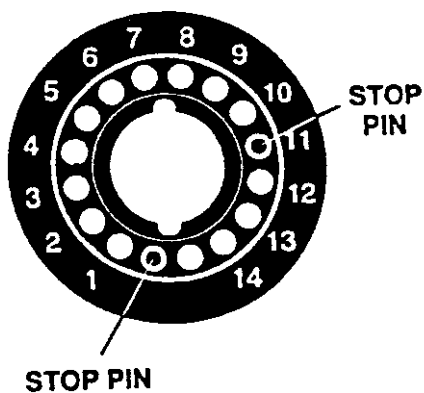

- After the frequencies and Code Guard values are entered for each channel, the Channel Selector knob can be modified to limit its travel. The procedure is as follows: Remove the Channel Selector knob from the radio. There are two pins. The pins can be set to limit the travel from two to 14 channels as needed. Place the pins in to the appropriate hole and reinstall the Channel Selector knob. For example, to limit the travel to channels 1-10 set the pins as shown in the illustration to the left.

2.3.9 LEAVE THE PROGRAMMING MODE

- Rotate the On/Off/Volume knob on the top of the radio counterclockwise to the Off position.
- Remove the programming plug.
- The radio will be in normal operation mode the next time it is turned on.

2.4 GROUP SELECTION

For a 210-channel radio, Channel 0 settings affect one "group" of 14 channels. Each group must be programmed separately. To select a group for programming, perform the following steps:

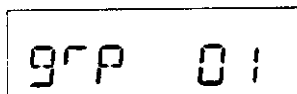

- Change the radio from programming mode to normal operation mode by turning it off, then on.

In normal operation mode, press the [#] key to display the current group number for 5 seconds. Press the [#] key a second time within 5 seconds to display the alphanumeric label for the current group.

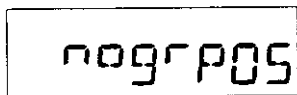

- To select a group to be programmed, press the [#] key followed by number keys for the group number. Enter the selection by pressing the [#] key or the [ENT] key, or by waiting 5 seconds.

If an invalid group number has been selected (for example, group 5) the LCD will display **no group 05**. To exit this mode either turn the radio off, then on; or enter a valid group number from the keypad.

- Enter the programming mode and set the values. See "Enter Programming Mode" on page 2-2.

NOTE: The same password code is used for all groups in the radio.

2.5 CLONING RADIO SETTINGS

A radio with a keyboard and display can transfer its programmed settings to another radio by using a cloning cable. A radio cannot transfer Alphanumeric display settings, including channel labels, group labels, and Channel 0 Group Three functions. Both units must be of the same frequency band. For example, an EPH series VHF radio can be used to clone settings to or from an LPH or LMH series radio.

The radio (with a keyboard and display) transferring its programmed settings is referred to here as a Master unit. The radio receiving the programmed settings is referred to here as a Clone unit.

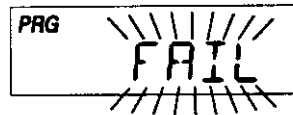
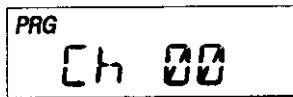
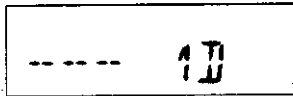
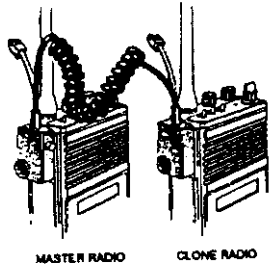

1. Make sure that both units are connected to a charged battery pack.
2. Attach the Master end of the cloning cable into the side connector of the Master radio. This is the cable end with the pushbutton Master switch.
3. Turn on the Master radio.
4. Put the Master radio in the programming mode by holding down the Master switch and pressing the [FCN] key until the LCD displays - - - ID.
5. Enter the correct Password Code.
6. Press the [FCN] key repeatedly to review the values in Channel 0. Make any required changes at this time.
7. Attach the other end of the cloning cable into the side connector of the radio to be cloned.
8. Turn on the clone radio.
9. Press the [*] key on the Master radio. The display will flash **PROG**, signifying that the radio is ready to download.
10. Press the [FCN] key. The program in the Master will download to the clone. The clone will send back the program to the Master to verify successful cloning.
11. If the download was successful, the Master radio will resume flashing **PROG**. Turn off the clone radio. Disconnect the cable. Normal radio operation will occur the next time the clone radio is turned on.
12. If the download was not successful the Master radio will flash **FAIL**, followed by continuous beeps. Failure to download the Master program can be due to:
 - A. Incorrect radio types.
 - B. Improper connection.
 - C. Failure to power up radio.
 - D. Clone set in programming mode.

NOTE: To stop FAIL mode, press the [CLR] key, turn off the radios, and start again at Step 1.

2.5.1 GROUP CLONING

Cloning radios equipped with more than 14 channels (more than one group) can only be accomplished group by group. Settings for any group in a Master radio can be downloaded to any group in the clone radio. To perform group cloning:

1. With the Master radio in normal operation mode, press the [#] key followed by number keys to select the group to be downloaded.
2. Set the clone radio to the group that is to receive the download, using the same method as in step 1.
3. Follow the cloning instructions on page 2-15.

Only the Channel 0 and channel 1-14 information for the selected Master radio group will be downloaded to the selected clone radio group. Channel 0 Group Three settings, other Alphanumeric settings, and labels cannot be downloaded by cloning.

2.5.2 SPECIAL CLONING INSTRUCTIONS

It is possible to change Channel 0 values on the Master radio, hold them in a temporary memory, and download them to the clone without actually entering them into the permanent memory of the Master radio. This is convenient for sequential identification numbers used to identify a series of portables in a radio system. Assuming that the frequencies, Code Guard values, and other Ch 0 values are common for all radios in the system, but that the radio identification number should be unique to each radio, the following method would be used to clone additional radios for the system.

1. Program the Master radio with all frequencies, Code Guard values, and Channel 0 values that will be common to all radios.
2. Advance the display to show the Master radio's ID number - for example, 100.
3. Press the [CLR] key; press 1 2 5. Do not press the [ENT] key. Now 125 is in temporary memory.
4. Press the [*] key, connect the cable to the radio and download by pressing the [FCN] key. ID number 125 is now stored in permanent memory of the clone.
5. After download, press the [CLR] key. Disconnect the clone. The Master radio display will show that 125 is still being held in the temporary memory of the Master radio.

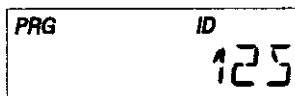



6. Press the **[PRI]** key. This will increment the ID number one digit to 126. (Note: any new number can be entered at this point by pressing the **[CLR]** key and using the digit keys to enter the new number.)
7. Press the **[*]** key. Connect the cable to the second clone and download by pressing **[FCN]**.
8. Any number of radios can be coded with different or sequential ID numbers using this technique. The ID number in the permanent memory of the Master radio will remain unchanged as 100.

2.5.3 SCAN LIST AND PRIORITY CHANNEL CLONING

When a Master radio downloads to a clone, the Scan List and Priority Channel designations are also transferred to the clone. This includes Priority Mode and any lockout functions.

To program a clone with a specific Priority Mode, Priority Channel, and Scan List along with the respective lockout functions (if desired), the Master radio must first be programmed with these parameters. The lockout functions cannot be held in temporary memory. See the appropriate operating procedures in Section 3 for selecting the Scan List, Priority Channel, and Lockout functions. See "Priority Scan" on page 2-6 for Priority Mode selection procedures.

2.6 PROGRAMMING BY COMPUTER

Programming a radio from a computer is not covered in this manual. Contact Bendix/King for the programming cable, software, and manual required.

2.7 TONE CODE GUARD VALUES

The tone Code Guard system may be set for any frequency in the range of 67 to 255.9 Hz. However, since most systems adhere to the Electronic Industry Association (EIA) standards, tones should be selected from the following EIA list. In order to insure optimum performance, tone selection for use on the same radio frequency (RF) channel or adjacent channels in the same coverage area should be made from one of the Groups A, B, or C to the maximum degree possible. BENDIX/KING guarantees optimum receiver performance only if tone frequencies below 220 Hz are chosen.

GROUP A		GROUP B		GROUP C
67.0 (XZ)	*151.4 (5Z)	71.9 (XA)	146.2 (4B)	74.4
77.0 (XB)	162.2 (5B)	82.5 (YZ)	156.7 (5A)	79.7
88.5 (YB)	173.8 (6A)	94.8 (ZA)	167.9 (6Z)	85.4 (YA)
*100.0 (1Z)	186.2 (7Z)	103.5 (1A)	*179.9 (6B)	91.5 (ZZ)
107.2 (1B)	203.5 (M1)	110.9 (2X)	192.8 (7A)	
114.8 (2A)	218.1 (M3)	*118.8 (2B)	210.7 (M2)	
123.0 (3Z)	233.6	127.3 (3A)	225.7 (M4)	
131.8 (3B)	250.3	136.5 (4Z)	241.8	
141.3 (4A)				

* 50/60 Hz power distribution systems could cause flashing.

The assignments in a given area shall be made from within one of the Groups: A, B, or C.

2.8 DIGITAL CODE GUARD VALUES

Codes for the Digital Code Guard system may be chosen from the following list. Since there are no EIA standards for the performance or compatibility of Digital Code Guard systems it is recommended that an operational test be made on the intended system before wholesale assignments are made. In some cases either or both the transmit and receive codes will require an inverted code to operate with existing systems. This can be done during the code programming of the system. Usually systems using direct unit to unit transmission (systems without mobile relays, repeaters, remote control, etc) may use codes from the table. Systems with relays etc. may use code variations for system control and operational efficiency. The system operator or engineer should be consulted regarding the operational requirement on such systems.

023	065	131	165	245	315	411	466	612	703
025	071	132	172	251	331	412	503	624	712
026	072	134	174	261	343	423	506	627	723
031	073	143	205	263	346	431	516	631	731
032	074	152	223	265	351	432	532	632	732
043	114	155	226	271	364	445	546	654	734
047	115	156	243	306	365	464	565	662	743
051	116	162	244	311	371	465	606	664	754
054	125								

SECTION III OPERATION

3.1 INTRODUCTION

This section contains information concerning the operation procedures for the EPH Series radio. Information on programming and installation is contained in Section 2 of this manual.

WARNING

DO NOT OPERATE THE TRANSMITTER IN CLOSE PROXIMITY TO BLASTING CAPS.

WARNING

DO NOT OPERATE THE RADIO IN AN EXPLOSIVE ATMOSPHERE (PETROLEUM FUELS, SOLVENTS, DUST, ETC.) UNLESS IT IS AN INTRINSICALLY SAFE MODEL DESIGNED FOR SUCH USE.

3.1.1 DISPLAY OPTIONS

EPH Series radios can be equipped with a standard 7-Segment Display, an Alphanumeric Display, or no display at all. Radios with either a 7-Segment Display or an Alphanumeric Display are also equipped with a keyboard.

An Alphanumeric Display shows channel and scanning information in a different way from a 7-Segment Display. The annunciators across the top of the display are arranged differently, but convey the same meaning. An Alphanumeric Display can also show letters, instead of just numbers.

Radios with Alphanumeric Display can be programmed to operate one or more groups in 7-Segment mode (see Section 2.3.6.5). The channel and scanning information will appear in the same way as a 7-Segment Display, but the annunciators are still different.

Display annunciators indicate the following information:

<u>7-Segment</u>	<u>Alpha-Numeric</u>	<u>Indication</u>
PR	PR	Priority Channel
PROG	PRG	Programming Mode (includes PR)
SCAN	SCN	Scan List Channel (On Alphanumeric Display, flashing SCN indicates Scanning in progress, and RX SCN indicates Receiving on a Scanned channel.)
TX	TX	Transmit
RX	RX	Receive- programming mode only
ID	ID	Automatic Number Identification (ANI) - programming mode only
CG	CG	User Code Guard- programming mode only
	GRP	Group Label (Alphanumeric Display only)

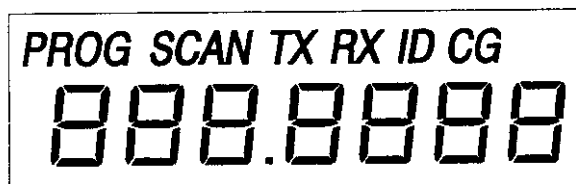

7-SEGMENT DISPLAY

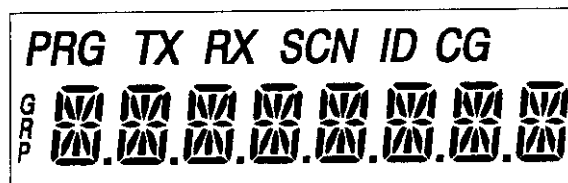

ALPHA NUMERIC DISPLAY

FIGURE 3-1 LIQUID CRYSTAL DISPLAYS

3.2 OPERATION

Operating procedures are basically the same for all three display types (7-Segment, Alphanumeric, and no display), with some obvious differences. For example, a radio with no display or keyboard has no keys to press. The actual display on the radio may appear different from the illustrations, depending on the features installed and programmed in the radio.

3.2.1 BASIC OPERATION

A. Receive

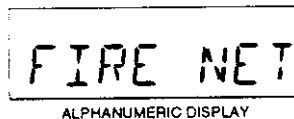
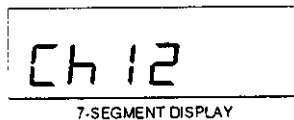
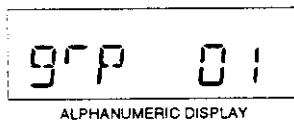

Turn power on by rotating the Volume knob clockwise past the OFF detent. The yellow LED will flash, the Display will show the current group number, then the channel number (7-Segment display) or channel label (Alphanumeric display). A beep will sound, indicating the radio is operational.

See channel label programming instructions on pages 2-13 and 2-10.

Rotate the Channel Selector knob to select the appropriate channel. Rotate the Squelch knob clockwise until a rushing noise is heard. Set the volume to a comfortable level, then rotate the Squelch knob backwards (counterclockwise) until the noise stops. This is called the threshold squelch setting.

Further rotation counterclockwise tightens the squelch setting, allowing only stronger signals to open the squelch and be heard. Full rotation counterclockwise past the detent places the receiver in Code Guard operation mode. A message will be heard only when the proper Code Guard is received.

B. Transmit

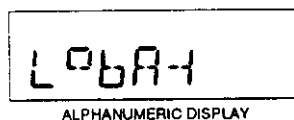
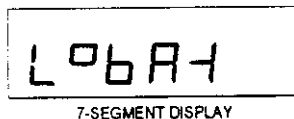

Press and hold the side Push To Talk (PTT) switch. The Display will show the TX annunciator and the red Transmit Indicator will glow when the transmitter is on. Talk in a normal voice with the microphone one to two inches from your lips. Make each transmission as brief as possible. Release the PTT switch to end transmission.

If the Transmit Indicator does not glow when you press the PTT Switch, the battery pack may need to be charged; if so, the Display will show **LOBAT** and the yellow Low Battery Indicator will flash. If the Transmit Indicator does not glow and a tone sounds, you are on a receive-only channel, or the channel is busy (if Busy Channel Lockout is installed). Rotate the Channel Selector knob to an authorized transmit channel.

If the length of your message exceeds the preset time out timer setting, the Transmitter will automatically shut off and a tone will sound. If you wish to continue this transmission, release the PTT switch, then press it again and continue talking.

3.2.2 CODE GUARD OPERATION

Code Guard™ allows one radio or group of radios to be selectively called within a system. If the radio has been programmed with Code Guard, use the following receive and transmit instructions.

A. Receive

Turn power on by rotating the Volume knob clockwise past the OFF detent. Rotate the Squelch knob clockwise until a rushing noise is heard. Set the volume to a comfortable level, then rotate the Squelch knob completely counterclockwise, past the detent for Code Guard operation. A message will be heard only when the proper Code Guard is received.

B. Transmit

Before transmitting on Code Guard channels, monitor the channel by turning the Squelch knob clockwise, off the detent. If the channel is not busy, press and hold the PTT switch. The red Transmit Indicator will glow when the transmitter is on. Release the PTT switch to end transmission. Reset the Squelch knob to the Code Guard position to receive only the transmissions with the proper Code Guard. During extended transmissions the squelch can be left open until the exchange has ended.

3.2.3 HI/LO TRANSMIT POWER

Placing the HI/LO toggle switch in the HI position enables full transmitter power. The LO position reduces power to the programmed low power setting, thereby reducing current drain and increasing battery life.

3.2.4 BUILT IN FEATURES

BENDIX/KING EPH Series radios are based on a microprocessor core that allows extra features and operational characteristics to be built into the radio. Dealers can help define the best operational settings for a system and program them into the radio.

Additional transmit and receive frequencies can be added. To monitor other local radio systems that fall anywhere in the band, a frequency with or without Code Guard can be added to the radio.

The radio comes equipped with a time out timer. This is used to limit the duration of calls and to guard against accidentally locking on the transmitter and tying up the radio system. The duration of the time out timer can be set from 0 to 225 seconds, in 15-second increments.

A DTMF/ANI encoding feature is also available on all keyboard/display models. If enabled, a sequence of DTMF tones similar to the tones used by a standard pushbutton telephone will be transmitted each time the transmit PTT switch is activated. If DTMF and ANI are both enabled, the ANI tone sequence will be transmitted only after the [ENT] key is pressed while the transmit PTT switch is activated. A sidetone of the ANI number transmitted will also be heard through the speaker. Dealers can program or change the ANI number to be sent.

A SCAN delay is included to allow a response to a transmission to be received before the scanner moves on to search for new activity. If the scanner is restarting before message replies are heard, the scan delay time can be increased. (0-7.5 seconds)

Radios equipped with the Alphanumeric Display can be programmed with custom channel labels and group labels. See "Group Label" on page 2-10, and channel label instructions on page 2-13, step 7.

Alphanumeric Display radios can also be programmed for LCD backlighting when a message is received or a key is pressed. See "Channel 0 Group Three Functions" on page 2-8.

There are three different priority modes available. These are discussed in the section Priority Operation on page 3-5. Dealers can help choose the best priority mode for a system.

Code Guard is a trademark of King Radio Corp.

3.2.5 OPERATIONAL FEATURES AVAILABLE

A. Scan Operation With Carrier Squelch

When in the Scan mode with carrier squelch set (not Code Guard), the radio receiver samples channels in a predetermined list (scan list) looking for activity. If an active channel is found, the scanning action stops and the message on that channel is heard. Once the message stops, the receiver will wait for a response before scanning resumes. This waiting period, called the "scan delay time," can be preset from 0 seconds to 7.5 seconds, in .5 second increments. The scan list can also be preset. On some radios the user will be able to add or delete channels from the scan list. The channel to which the Channel Selector knob is set is always included in the scan list, whether it is programmed for scan or not.

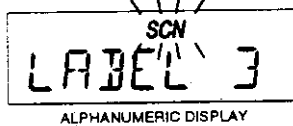
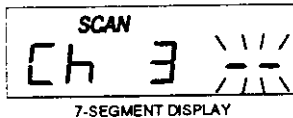

To begin scanning, place the SCAN toggle switch in the SCAN position. Place the Priority Scan toggle switch (PRI) in the off position (down). See "Priority Operation" on page 3-5.

Scan operation occurs only while the radio is not transmitting. SCAN operation is indicated by two flashing bars (7-Segment display) or a flashing SCN annunciator (Alphanumeric display).

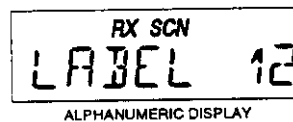
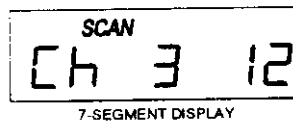

When a signal is detected, scanning stops and the signal being received is heard. The active channel is shown on the right side of the display (7-Segment display) or in place of the transmit channel (Alphanumeric display). The radio receiver stays on that channel until activity ceases and resumes scanning after the "scan delay" time.

If you wish to transmit on the last active scan channel, turn the Channel Selector knob to that channel. Turn OFF the SCAN toggle switch for normal transmit/receive operation.

When the PTT is pressed while in the scan mode, the radio transmits on the channel selected by the Channel Selector knob. Upon release of PTT, the radio receiver will hold on that channel. If no reply occurs during the "scan delay" time, the radio resumes scanning.

B. Scanning Code Guard Channels

To scan for channels with programmed Code Guard, rotate the Squelch knob completely counterclockwise, past the detent. When a signal is detected, scanning stops and the Code Guard for that channel is checked. If the proper Code Guard is present, the radio receives that channel until Code Guard ceases. If the proper Code Guard is not present the radio receiver will resume scanning immediately.

C. Changing the Scan List

The radio can be programmed with a permanent or changeable scan list. If the scan list can be changed, use the following steps to enter or clear channels.

To avoid confusion, turn OFF the PRI and SCAN toggle switches on the top of the radio.

Turn the Channel Selector knob to the channel to be entered or cleared.

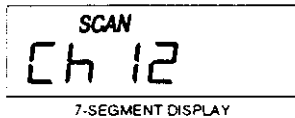

To ENTER a channel into the scan list, press the [ENT] key on the keyboard. A short beep will be heard. The display will show the annunciator "SCAN" (7-Segment display) or "SCN" (Alphanumeric display).

To CLEAR a channel from the scan list, press the [CLR] key. A short beep will be heard, and the "SCAN" or "SCN" annunciator in the display will disappear.

D. Permanent Scan List

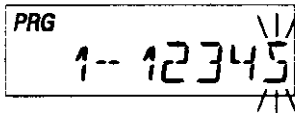

To make the scan list permanent or changeable, program the function to either enabled or disabled. See "Scan List Lockout" on page 2-6.

E. Priority Operation

Priority operation consists of receiving on any channel while still monitoring for a message on the priority channel. Priority can also be used in combination with Scan operation. When scanning a priority channel that uses Code Guard, the radio will lock on to that channel, but a message will be heard only when the correct code has been detected. The radio will resume scanning after the signal has ended and the scan delay time has expired.

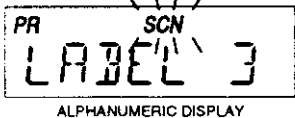
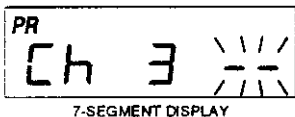

When the PRI (priority) toggle switch is turned ON, the channel designated "priority" is sampled at a preset rate (.25 to 3.75 seconds) regardless of activity on any other channel. The display flashes two bars (7-Segment display) or "SCN" (Alphanumeric display) to indicate that the radio is sampling the priority channel. If a signal is received on the priority channel, the radio receiver will lock on to that channel for the duration of the transmission.

When the SCAN toggle switch is ON and the PRI toggle switch is OFF, normal scanning will occur but the priority channel will not be sampled. If both scan and priority toggles are off, the radio will function as in basic operation.

Priority Modes

Priority Mode A -- The priority channel is tied to the Channel Selector knob. When the selector is set on channel 5, this is the priority channel. If the selector is switched to channel 8, this becomes the priority channel. You will transmit on the frequency chosen by the Channel Selector knob.

Priority Mode B -- The priority channel is fixed. You will transmit on the frequency chosen by the Channel Selector knob.

Priority Mode C -- The priority channel is fixed. When the PRI toggle switch is ON, you will transmit on the priority channel regardless of the Channel Selector knob setting.

Which Priority Mode is Installed

Follow these steps to determine which priority mode is set in a radio equipped with a keyboard and display.

1. Set the PRI and SCAN toggle switches to OFF.
2. Rotate the Channel Selector knob, stopping at each detent to view the LCD Display.
3. If a "PR" symbol (in the upper left of the LCD Display) does not appear for any channel, you have priority Mode A.
4. If "PR" is displayed, rotate the Channel Selector knob to a different channel, then turn the PRI toggle ON.



If the LCD channel stays on the selected channel, you have priority Mode B.

If the LCD channel changes to the priority channel, you have priority Mode C.

Priority Mode A Details

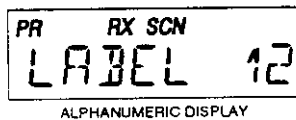
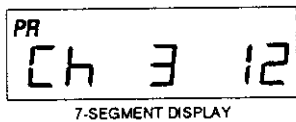

In this mode, the priority channel is tied to the Channel Selector knob. When the SCAN and PRI (priority) Toggle Switches are ON, scanning will occur until an active scan channel is found. The radio will receive the active channel while continuing to sample the priority channel. If during this sampling the priority channel becomes active, the Priority Indicator will light. The radio receiver will go to the priority channel and hold for the duration of the transmission. The priority channel will be shown the display (on the right hand side of 7 Segment displays).

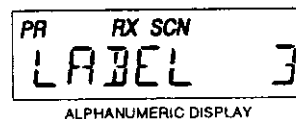
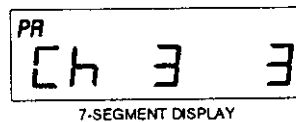

If you wish to reply to a message on the priority channel, press the PTT and you will transmit on the priority channel. Once activity ceases on the priority channel, the radio returns to scan operation.

Priority Mode B Details

This mode fixes one channel in the radio as the priority channel. With the SCAN toggle switch OFF and PRI (priority) toggle switch ON, the radio can receive on the knob-selected channel while still sampling the priority channel. If the priority channel becomes active, the Priority Indicator goes on and the radio holds on the priority channel for the duration of the transmission. If you wish to reply to a message on the priority channel, you must rotate the Channel Selector knob to the priority channel, then transmit.

With both SCAN and PRI toggle switches ON, the radio will scan until it locks on to an active channel. The radio continues to sample the priority channel while listening to the active channel. If activity occurs on the priority channel, the radio will override the active scan channel, go to the priority channel, and hold for the duration of the transmission. If you wish to reply to a message on the priority channel, rotate the Channel Selector knob to the priority channel, then transmit. Once activity has ceased on the priority channel, the radio returns to scan operation.

Priority Mode C Details

With the PRI toggle switch ON and SCAN switch OFF, radio operation is much the same as in Mode B. The fixed priority channel is sampled at the preset rate. If activity occurs on the priority channel, the radio will go to the priority channel and hold for the duration of the transmission. If you wish to reply to a message heard on the priority channel, press the PTT switch and the radio will automatically transmit on the priority channel regardless of the setting of the Channel Selector knob. In Priority Mode C the radio will always transmit on the priority channel if the PRI toggle switch is ON. The Priority Indicator will come on as a reminder that you are transmitting on the priority channel. Once activity has ceased on the priority channel, the radio will return to the Channel Selector knob receive channel.

With both SCAN and PRI toggle switches ON, the radio will scan until it locks on to an active channel. The radio continues to sample the priority channel while listening to the active channel. If activity occurs on the priority channel, the radio will override the active scan channel, go to the priority channel and hold for the duration of the transmission. If you wish to reply to a message on the priority channel, press the PTT switch and the radio will automatically transmit on the priority channel, regardless of the setting of the Channel Selector knob. In Priority Mode C the radio will always transmit on the priority channel if the PRI toggle switch is on. The Priority Indicator will come on to remind you that you are transmitting on the priority channel. Once activity ceases on the priority channel, the radio returns to scan operation.

F. Changing the Priority Channel

The fixed priority channel used in Priority Modes B and C may be permanently set or may be changeable. See "PRI Key Lockout" on page 2-6. If the radio has a changeable priority channel, use the following steps to make this change.

NOTE: Only one channel can be designated as the priority channel.

1. To avoid possible confusion, turn OFF the PRI and SCAN toggle switches on the top of the radio.
2. Rotate the Channel Selector knob to the channel that you wish to enter as the new priority channel.
3. Press the [PRI] key. A short beep will sound, and the "PR" annunciator will be displayed, indicating that the displayed channel is now the priority channel.

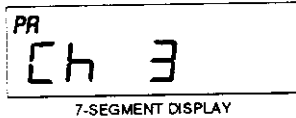

7-SEGMENT DISPLAY



ALPHANUMERIC DISPLAY

A channel can be both a priority and a scanned channel. Due to multiple sampling of the same channel, maximum performance occurs when the priority channel is not also a scan channel.

G. Setting Priority Channel Lockout

1. To lockout a priority channel setting the radio must first be programmed for priority mode B or C.
2. With the radio in normal operation mode set the channel select knob to the desired priority channel.
3. Press the [PRI] key on the keyboard. If the PR annunciator appears on the display, the PRI Key Lockout function is disabled. If the PR annunciator does not appear on the display, the PRI Key Lockout function is enabled.
4. Program the PRI Key Lockout function to either enabled or disabled. See "PRI Key Lockout" on page 2-6.

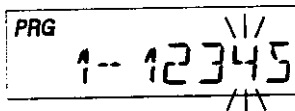

H. User Code Guard Selection

Certain Bendix/King Radio models with keyboard and display allow user selection of Code Guard values independent of the Channel Selector knob setting. This is accomplished using the keyboard. The radio can be programmed to enable or disable this feature. The programming has also assigned a transmit frequency and Code Guard and a receive frequency and Code Guard to each position shown on the Channel Selector knob. The Code Guard values for Channels 1-9 can be pulled away from their normal pairing and matched with any of the other frequencies in the radio.

For example, to use the Code Guard values of Channel 9 with the frequencies of Channel 5:

1. Turn OFF the PRI and SCAN toggle switches on the top of the radio.
2. Set the Channel Selector knob to Channel 5.

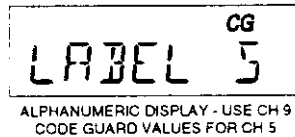
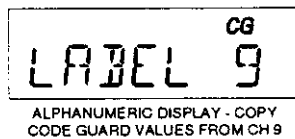
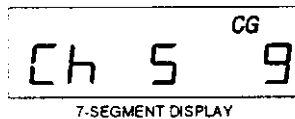

3. Press the [9] key on the radio keyboard. The CG annunciator will be displayed.

The radio will now operate on the frequencies of Channel 5 with Channel 9 Code Guard values.

The 7 Segment display will show the selected channel on the left (5) and the Code Guard value channel on the right (9).

The Alphanumeric display will show the Code Guard value channel, then the selected channel. To see the Code Guard value channel again, press the [#] key on the keyboard. The group number will be displayed, followed briefly by the Code Guard value channel, then the selected channel.

4. Press the [0] key to reset all values to the original programming, or press a different digit key (1-9) to select a new set of Code Guard values.

NOTE: In scan or priority scan mode, the display will not show selected user Code Guard values, nor will it use operator-selected Code Guard values in scan mode.

NOTE: Once a Code Guard value has been selected by the keyboard it will not change even if power is interrupted or if the Channel Selector knob is changed.

I. Busy Channel Operation

If the radio has been programmed for busy channel operation, it will operate in one of the following three modes.

Busy Channel Indication

The yellow Busy Channel Indicator will glow if there is carrier activity on the channel selected. If the channel selected is a Code Guard channel and the correct code is not detected, the Busy Channel Indicator will remain on for the duration of the carrier activity and no messages will be heard. During Scan and Priority Scan operation, the Busy Channel Indicator will glow when activity is detected on any channel that is in the scan list. When scanning Code Guard channels, with the Squelch knob set to the Code Guard position, and the activity has been detected, the Busy Channel Indicator will glow for the time period necessary to determine if the proper Code Guard has been received, causing the LED to "flash" at various rates. In Priority Scan operation, the Busy Channel Indicator will remain on for the duration of the carrier activity on the priority channel whether the correct Code Guard is detected or not.

Busy Channel Lockout

The Busy Channel Lockout feature applies only to those channels programmed for receive Code Guard operation. When carrier activity has been detected on the channel selected, the receive Code Guard is checked. If the proper code is present, you will be able to transmit on that channel. If an incorrect code or carrier activity only is detected, even if the Squelch knob is not in the Code Guard position, the transmitter is disabled, an alert tone is heard, and the LCD displays the word "Busy" when the radio's PTT is depressed.

Channels not programmed for receive Code Guard operation will transmit regardless of carrier activity.

Busy Channel Lockout Override

This mode operates in the same manner as Busy Channel Lockout except that the user can override and transmit by turning the Squelch knob off the Code Guard detent. The transmitter is locked out only if the Squelch knob is set to the Code Guard detent.

J. ANI Operation

A DTMF/ANI encoding feature is also available on all models. If enabled, a sequence of DTMF tones similar to the tones used by a standard pushbutton telephone will be transmitted each time the transmit PTT switch is activated. A sidetone of the ANI number transmitted will also be heard through the front speaker.

When DTMF and ANI are both enabled the ANI tone sequence will be transmitted only after the [ENT] key is pressed while the transmit PTT switch is activated. A sidetone of the ANI number transmitted will also be heard through the speaker.

K. DTMF Operation

Portable radios equipped with a keypad can be used for DTMF encoding. The radio can be programmed to enable or disable this feature. To operate the DTMF function simply press and hold the PTT switch and press any of the 12 keys desired. An audible sidetone will be heard through the front speaker.

The [FCN], [PRI], [ENT], and [CLR] keys respond as DTMF tones A, B, C, and D respectively.

3.2.6 GROUP OPERATION

A. Group Description

The Channel Selector knob has 14 positions. Radios with more than 14 channels are separated into "groups" of 14 channels each.

For simplification purposes each group should be looked at as an individual 14-channel radio. Each group can be programmed to have an "individual personality" with the operational features described earlier.

Radios with an Alphanumeric display can be programmed with group labels. See "Group Label" on page 2-10.

B. Group Selection



7-SEGMENT DISPLAY

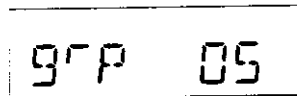

ALPHANUMERIC DISPLAY

To avoid confusion, switch the SCAN and PRI switches to the OFF position. By pressing the [#] key on the keypad, the display shows you which group you are operating in. For example, this illustration shows the display indicating **grp 05**. Press the [ENT] key or wait approximately 5 seconds; the radio reverts to normal operation and the display shows the channel selected.

With an Alphanumeric display pressing the [#] key a second time shows the group label. Press the [ENT] key or wait approximately 5 seconds; the radio briefly displays the User Code Guard channel label (if any) then reverts to normal operation and displays the label of the channel selected.

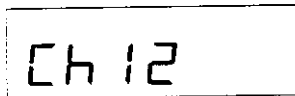

7-SEGMENT DISPLAY

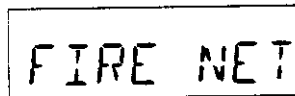

ALPHANUMERIC DISPLAY

To change groups, press the [#] key followed by the group number desired. Press the [ENT] key or wait approximately 5 seconds; the radio reverts to normal operation for that group and the selected channel appears in the display. All scanning and priority functions selected affect only the channels in the group you are operating in.

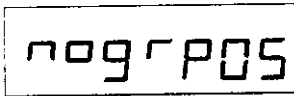

7-SEGMENT DISPLAY

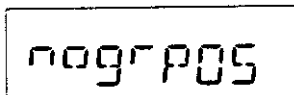

ALPHANUMERIC DISPLAY

When changing groups, if a non-programmed or invalid number is selected (05, for example), the display will show **nogrP05** and the radio will return to the previously selected group.



SECTION IV THEORY OF OPERATION

4.1 INTRODUCTION

This section contains the theory of operation for the EPH Series transceivers. To aid in understanding the operation of the equipment, schematic diagrams are found in Section VI of this manual.

4.2 EQUIPMENT DESCRIPTION

The EPH series radios are self-contained VHF FM Transceivers operating in the 148MHz to 174MHz band. EPH radios are digitally synthesized and use a single crystal for frequency control. An EEPROM is incorporated for the storage of channel frequency, Code Guard, and Dual Tone Multiple Frequency/Automatic Numeric Identifier (DTMF/ANI) encode information. LEDs indicate transmit, priority, low battery, and busy channel.

Toggle switches control high/low transmit power, priority scan, and multi-channel scan. Status and channel information is displayed over a liquid crystal display (LCD) on Keyboard/Display models. Connectors are provided on the side of the unit for external antenna, microphone, speaker, and other optional accessories. A variety of twist-off battery packs are also available. Usable channels are dealer programmable.

4.3 THEORY OF OPERATION

Circuitry for the EPH series transceivers is comprised of four major circuits:

The RECEIVER consists of RF preselectors, RF amplifier, mixer, IF filters, IF amplifiers, FM IF chip, and noise squelch circuitry.

The TRANSMITTER consists of power amplifier, harmonic filter, antenna switch, and power control circuitry.

The SYNTHESIZER consists of voltage controlled oscillator (VCO), VCO buffer, prescaler buffer, prescaler, synthesizer IC, reference oscillator, loop filter, and acquisition aid bit circuitry.

The SYSTEMS AREA consists of microprocessor, microprocessor oscillator, EEPROM, signaling and switching, front end tuning, 5V and 8.2V regulators, transmitter audio, deviation compensation, squelch threshold circuitry, and receiver audio.

4.3.1 RECEIVER

The receiver is a dual conversion design with intermediate frequencies of 16.9MHz and 455kHz. RF signals received at the antenna pass through the antenna switch and front end. The front end consists of an amplifier and 2 microprocessor tuned bandpass filters. The front end amplifies the receive frequency and attenuates image, half IF and other frequencies that degrade receiver performance.

RF signals from the front end enter a mixer which converts them to 16.9MHz. The 16.9MHz IF signal passes through 2 crystal filters which provide adjacent channel selectivity. The IF amplifier then amplifies the signal and couples it to the 455kHz IF integrated circuit. The 455kHz IF chip consists of a mixer, limiter, demodulator, and squelch circuit. The 16.9MHz signal enters the mixer and is converted to a 455kHz IF signal. A ceramic filter at 455kHz provides more adjacent channel selectivity. The signal is then amplified by the limiter and demodulated. Audio processing is then done on the options board. Filtered audio noise is used to provide a squelch indication.

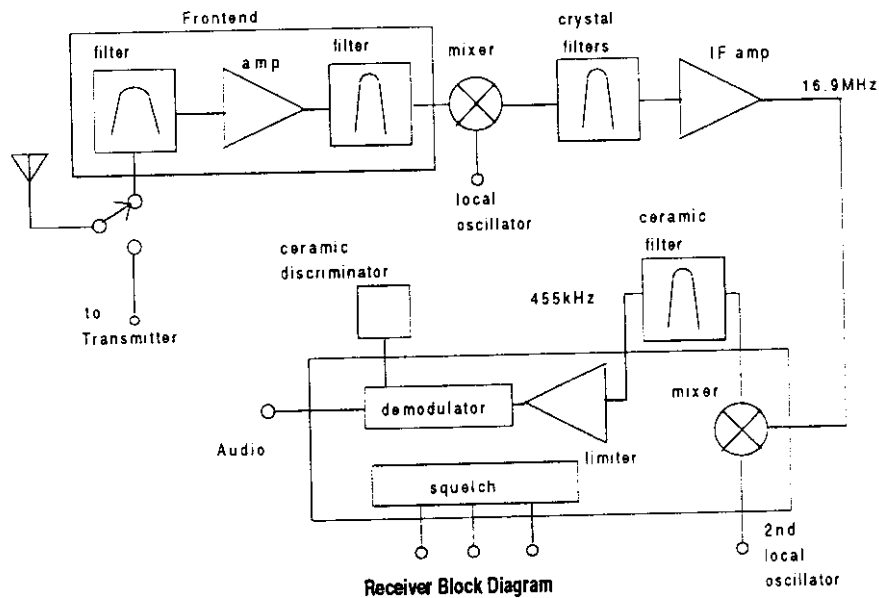

A. RF PRESELECTORS

The preselectors provide greater than 75db of attenuation at the image frequency. Both bandpass filters are varactor tuned which allows a wide frequency spread. Overall the preselectors exhibit a bandwidth of 4.5Mhz. The preselectors consist of L2, L3, L4, L5, and associated circuitry.

B. RF AMPLIFIER

The RF amplifier is a single transistor amplifier providing 22db of gain. The amplifier consists of Q1 and associated circuitry.

C. MIXER

The balanced diode mixer converts the RF frequency to 16.9MHz. The mixer consists of CR6, CR7, CR8, CR9, and associated circuitry.

D. IF FILTERS AND IF AMPLIFIERS

The crystal filters FL1A and FL1B are centered at 16.9MHz and provide attenuation to frequencies adjacent to the receive frequency. The bandwidth of the filters is 15kHz. The IF amplifier provides 26db of gain at 16.9MHz. The amplifier consists of Q4 and associated circuitry.

E. FM IF CHIP

The FM IF chip I2 provides a 2nd mixer, a high gain limiter, a demodulator, an OP-AMP and a schmitt trigger. The mixer converts the 16.9Mhz signal to 455kHz. The Local oscillator for the mixer consists of a 17.355Mhz crystal (Y1) and associated circuitry. The 455kHz signal is filtered by a ceramic filter FL2. A limiter inside I2 provides most of the gain for the receiver. The FM signal is demodulated by the demodulator in I2, the ceramic discriminator FL3 and associated circuitry.

F. NOISE SQUELCH

The demodulated audio is bandpass filtered with an active filter consisting of I2's internal OP-AMP and external circuitry. Squelch gain control is provided by Q6 and associated circuitry. The squelch noise is detected by I2's internal schmitt trigger. The microprocessor samples the schmitt trigger output to determine signal level and squelch information.

4.3.2 TRANSMITTER

The transmitter consists of four major blocks (see figure). These are:

- (1) Power Amplifier
- (2) Harmonic Filter
- (3) Antenna Switch
- (4) Power Control

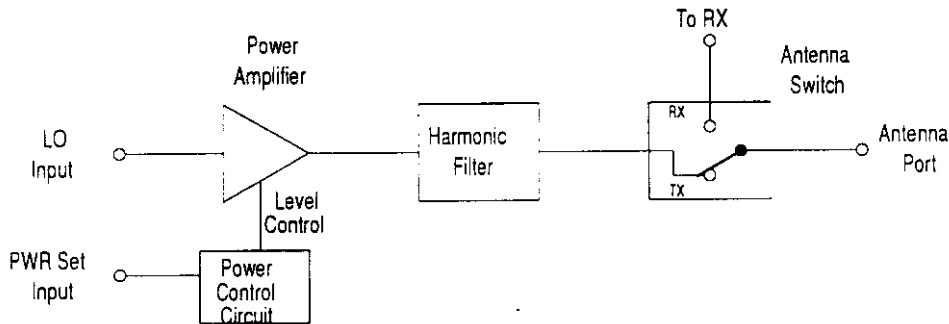

Transmitter Block Diagram

The power amplifier provides the necessary gain to amplify the low level 1st local oscillator signal to a level of 5 watts (2 watts for 2 Watt models).

The harmonic filter is a seven pole lowpass filter which provides rejection of the transmit frequency's harmonics.

The antenna switch switches the RF signal path from the antenna port to the transmitter while in transmit mode. In receive mode the path is made from the antenna port to the receiver.

The power control circuit uses feedback control to level the RF power out of the transmitter. The desired transmitter output power is adjusted by means of the PWR SET line voltage for levels between 1 watt and 5 watts (1.5 watts and 2 watts for 2 Watt models).

A. POWER AMPLIFIER

The power amplifier is comprised of four RF amplifier stages(see figure). These are:

- (1) Low Level Amplifier
- (2) Predriver Stage
- (3) Driver Stage
- (4) Final Stage

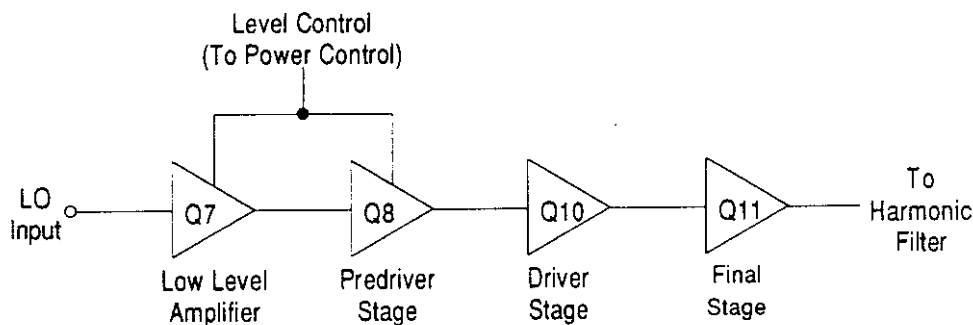

Power Amplifier Block Diagram

The low level amplifier is a class A amplifier stage. At rated output power a nominal input level of +2 dBm from the VCO buffer is amplified to a nominal level of +10 dBm (+9dBm for 2 Watt models). The bias to this stage is adjusted by the power control circuit for a variation in gain and output level required for power leveling and low transmitter output power settings.

The predriver is also a class A amplifier. At rated output power it amplifies a nominal signal level of +10 dBm to a nominal level of +17.5 dBm (+9 dBm to a nominal level of +14 dBm for 2 Watt models). This stage too has variable bias controlled by the power control circuit.

Bias to the low level amp(Q7) and predriver(Q8) is switched through Q12 in transmit mode. It is also filtered to suppress feedback on the positive bias line which may cause oscillations. In receive mode Q12 does not conduct and the collector of Q12 is pulled low, thus removing bias to Q7 and Q8. This turns off the transmitter.

The driver is a class C amplifier with a nominal gain of 10 dB (8dB for 2 Watt models). Its RF input signal, provided by the predriver is amplified to a nominal level of +27.5 dBm (+22dBm for 2 Watt models).

The final stage is a class C amplifier. It has a nominal gain of 10 dB (11.5 dB for 2 Watt models). Its RF input signal provided by the driver is amplified to a nominal level of +37.5 dBm (5.6 watts) for 5 watt models, and to 33.5 dBm (2.25 watts) for 2 Watt models.

B. HARMONIC FILTER

The harmonic filter is a 7 pole elliptical lowpass filter. It attenuates the harmonics created by the power amplifier to levels more than 60 dB below the carrier. The input and output impedances of the filter are designed to be 50 ohms within the radio's band of operation (20 ohms in and 50 ohms out for 2 Watt models). The elements which make up the harmonic filter are C67, C68, C69, C70, C71, C72, C73, L24, L25, and L26.

C. ANTENNA SWITCH

The antenna switch serves as a single-pole double-throw switch for RF signals.

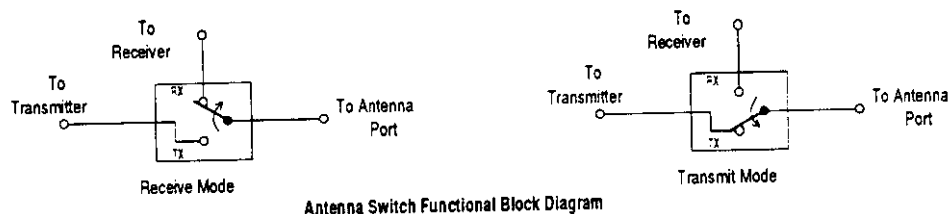

1. RECEIVE MODE

In receive mode the receiver is connected to the antenna as shown(see figure). Q12 turns off bias to CR1 and CR13 which appear as open circuits to RF signals. Components C1, C2, C3, C5, and L1 then match the receiver to 50 ohms.

2. TRANSMIT MODE

In transmit mode the transmitter is connected to the antenna port as shown(see figure). Q12 conducts turning on CR1 and CR13. Bias current is set by R52. Components C1, C2, C74, and L1 then match the output of the harmonic filter to 50 ohms.

D. POWER CONTROL CIRCUIT

The power control circuit monitors the supply current in the power amplifier's final stages. This current is nearly proportional to the transmitter output power and is kept constant by the power control in order to level output power.

The power control is implemented in four steps.

1. Supply current is sensed in the final amplifier stages. A 100 milliohm resistor (R14) in the supply line develops a voltage at its terminals which is proportional to the supply current.
2. An error voltage is created with the current sense voltage and the PWR SET voltage. This is accomplished in a resistor bridge.
3. The error voltage is amplified using an operational amplifier (I3).
4. The amplified error voltage controls the supply current to the low level and predriver amplifier stages by means of an FET in the supply return path (Q9). This varies the gain of these stages.

Varying the gain in the low level and predriver amplifiers varies the drive level to the driver and final. This has the desired effect on transmitter current and thus on transmitter power in the final stages.

4.3.3 SYNTHESIZER

The purpose of the synthesizer is to generate an RF signal either to downconvert a desired receive frequency to a fixed IF (16.9 MHz) or to drive the transmitter. The synthesizer is essentially a phase locked loop that locks the RF output of a voltage controlled oscillator (VCO) to a very stable lower frequency reference. The microcontroller determines the frequency that the synthesizer produces by programming the dividers contained within the synthesizer IC.

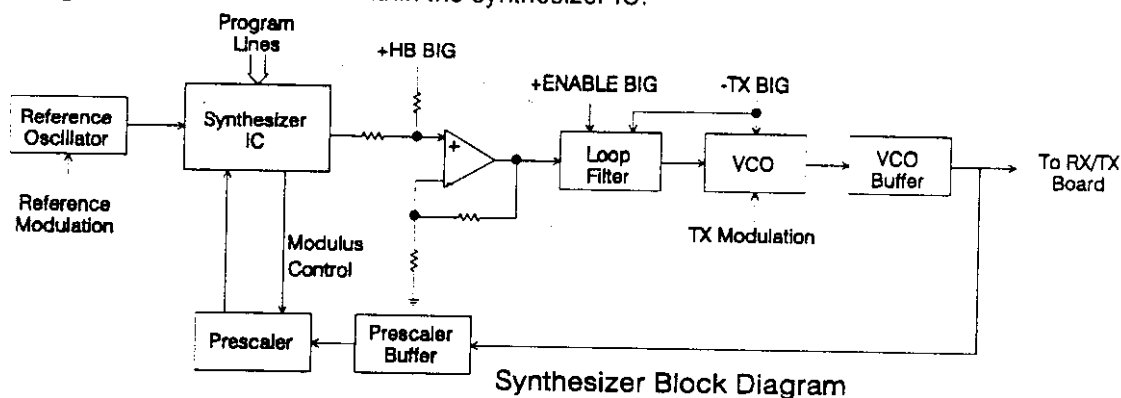

A. VOLTAGE CONTROLLED OSCILLATOR (VCO)

Transistor Q4 provides the gain and an L-C resonant tank circuit provides the frequency selectivity and phase shift necessary to produce an oscillator. Frequency control of the oscillator is accomplished by the tuning tank circuit comprised of mechanically adjustable transformer T1 and varactors CR4 and CR5. CR4 is used to lock the VCO to the desired carrier frequency while CR5 is used in the transmit mode to modulate the carrier. The oscillator frequency range is 148-174 MHz in the transmit mode and 131.1-157.1 MHz in the receive mode (low side injection). The 16.9 MHz shift from transmit to receive is achieved by turning on PIN diode CR3, thus adding L4 to the tank circuit. Q5 and associated circuitry provide additional power supply filtering for the VCO. Diode CR6 gives the filter a rapid power up response while maintaining a very low cutoff frequency.

B. VCO BUFFER

The VCO buffer is a cascode configuration with bipolar transistor Q3 feeding common gate FET Q21. It isolates the VCO from the receiver/transmitter circuitry and provides enough power gain to supply a nominal level of +3dBm in receive and +0dBm in transmit.

C. PRESCALER BUFFER

Prescaler buffer Q2 provides isolation between the prescaler and receiver/transmitter circuitry and additional isolation between the prescaler and the VCO.

D. PRESCALER

Prescaler I11 is an emitter coupled logic device which divides down the RF signal provided by the prescaler buffer to a frequency which can be processed by the following CMOS dividers. The prescaler is of the dual modulus type which allows the divide value to be set by the synthesizer IC to either divide-by-40 (modulus control line high) or divide-by-41 (modulus control line low). This capability allows the RF signal frequency to be divided by integers that are not multiples of either 40 or 41.

E. SYNTHESIZER IC

Synthesizer chip I12 contains three programmable CMOS dividers, a sample-and-hold phase detector, and an amplifier which forms an on-chip reference oscillator when connected to the terminals of an external crystal (Y1). The first divider (divide-by-R) divides down the reference oscillator to a frequency which is used as a reference by the sample-and-hold phase detector. The second divider (divide-by-N) divides down the output of the prescaler to a frequency which is equal to the divided down reference frequency when the loop is locked. The third divider (divide-by-A) controls the modulus control line of the prescaler. The sample-and-hold phase detector provides a DC voltage that is proportional to the phase error between the divided down reference and the divided down carrier. This voltage is fed through the loop filter to the VCO and adjusts the VCO frequency in a direction to maintain phase and frequency lock between the two divided down signals.

F. REFERENCE OSCILLATOR

The reference oscillator provides the reference frequency from which the receiver and transmitter injection signals are synthesized. The oscillator frequency is controlled by crystal Y1 which operates in the parallel resonant mode across an amplifier built into the synthesizer IC. This crystal is compensated to plus or minus 5ppm by a temperature compensating circuit built around transistor Q1, thermistor RT1, and varactors CR1 and CR2. In addition, a method of modulation is provided to improve the synthesizer frequency response to low frequency modulation.

G. LOOP FILTER

The loop filter removes noise and unwanted frequency components from the output of the sample-and-hold phase detector which would otherwise modulate the VCO. It employs a multiple filter bandwidth design which allows fast response during frequency changes (such as in Channel Scan) without degrading the noise and spurious performance of the synthesizer during steady state receive or transmit conditions. The filter is switched to a wide bandwidth condition when the +ENABLE BIG line pulses high for approximately 4 msec during a frequency change. This allows the new frequency to be reached quickly. When the +ENABLE BIG line returns to the low state, the filter bandwidth changes to a narrow condition and provides for good noise and spurious performance. Finally, different filter bandwidths are used from transmit to receive to provide better hum and noise performance on transmit and better response time on receive. This is accomplished by changing the filter bandwidth to a narrower value when the -TX BIG line goes low during transmit.

H. ACQUISITION AID BIT

The +HB BIG signal summed with the synthesizer IC phase detector output prior to the loop filter helps to keep the phase detector operating near the middle of its range. This bit is low for the lower half of either the receive or transmit band, and high for the upper half of either band.

4.3.4 SYSTEMS AREA

A variety of functions is included in the systems area.

A 5 volt precision voltage regulator provides power to the microprocessor and several other ICs in the radio. The -RESET signal from this circuit will prevent any radio functions if the battery voltage falls too low. The 8.2 volt regulator is used for synthesizer and VCO functions. An output signal will alert the processor if the battery voltage falls too low for proper operation.

Several special transmitter features are implemented by the microprocessor. These include repeater-talk-around, busy channel lockout, DTMF generation, ANI generation, sub-audible Code Guard generation, and time out timer.

Receive mode special features provided by the microprocessor include channel scan, priority scan, scan hold timer, battery saver, and tone and digital guard decoding.

Other functions performed by the microprocessor are synthesizer control and data loading, channel and hardware information storage, provision of a receiver front end tuning voltage, interpretation of the user switches, generation of display information, and remote and keypad programming mode.

A. MICROPROCESSOR

The microprocessor (I1) receives inputs from user switches and controls radio functions such as loading the synthesizer, adjusting the transmitter deviation, tuning the receiver, setting transmit power, time out functions, etc.

B. MICROPROCESSOR OSCILLATOR

The microprocessor oscillator consists of Y2, R82, C45, C44, R98, R99, and Q22. The frequency of oscillation can be altered slightly by Q22 to prevent interference when tuned to receive channels that are exact multiples of 4 MHz.

C. EEPROM

The EEPROM (I7) stores channel information and hardware compensation values. It is switched off to conserve energy by Q13 when not in use.

D. SIGNALING AND SWITCHING

The signaling D/A and switching network consists of RN1, I4, and I14. This circuitry allows the microprocessor to generate DTMF and ANI tones, transmit code guard, and various audio beeps heard in the speaker.

E. FRONT END TUNING AND POWER SET

The front end tuning and power set D/A converter is composed of a serial loaded register (I2) a resistor network (RN2) and amplifier (I3). In receive mode the voltage from RN2 is used to tune the front end filters on the Rx/Tx board. In transmit mode it is used to set the transmitter power.

F. 5V REGULATOR AND LOW VOLTAGE RESET

I8 provides a regulated 5 volt supply for the radio. An output signal from the regulator will force the microprocessor into a reset condition if the battery voltage drops below about 5 volts.

G. 8.2V REGULATOR AND LOW BATTERY SHUTDOWN

An 8.2 volt regulator is composed of I3, Q10, and associated circuitry. Regulator operation is monitored via Q11. The microprocessor will shut down radio operation if a low battery or 8.2 volt short circuit occurs. I14 is used to switch the regulator off during battery saver mode.

H. RECEIVE AUDIO

I9 is a .5 Watt audio amplifier. Muting is controlled by the microprocessor via Q16.

I. DEVIATION COMPENSATION

The transmit modulation deviation compensation network consists of R42 thru R45. At higher transmitter frequencies less voltage is needed for VCO modulation, so this circuit attenuates the signal. Also, when guard tones are being transmitted, the deviation sensitivity is reduced by approximately 15% so that 5 KHz peak deviation is not exceeded.

J. CHANNEL SWITCH MULTIPLEXER

The channel switch multiplexer (I5) allows four lines to the microprocessor to be shared between two different functions. In receive mode, the channel selector switch position may be examined via I5. In transmit mode, I5 is used to disconnect the channel switch from the microprocessor so that these signals may be used for the deviation compensation circuitry.

K. SQUELCH THRESHOLD PRESET

Pin 11 of I5 is used to switch a resistor into the squelch circuit thus lowering the squelch threshold when the Squelch knob is in the "preset" position.

SECTION V MAINTENANCE

5.1 INTRODUCTION

This maintenance section contains test and alignment procedures for an operational EPH Series radio. This section also contains troubleshooting and assembly/disassembly procedures. An understanding of the theory of operation is recommended before maintenance is attempted.

5.2 TEST EQUIPMENT REQUIRED

- A. RF Signal Generator: HP8640B or equivalent
- B. Distortion Analyzer: HP334A or equivalent
- C. RF Voltmeter (optional): Boonton 92C or equivalent
- D. RF Power Meter: HP435B with 30 dB pad or equivalent
- E. Service Monitor: Cushman 4000 Radio Communications Test Set or equivalent
- F. Digital Multimeter: Fluke 8012A or equivalent
- G. Programmer: Companion radio with keyboard display.
(for non-keyboard/display units only)
- H. Computer: IBM PC or compatible, with 256K memory and an RS-232 serial port
LAA0705 or LAA0725 programming cable
EPH frequency programming software
EPH RX/TX tuning software
- I. Portable Tool Kit LAA0600, P/N 050-02567-0000.
This tool kit consists of the following parts:
 - Antenna Adaptor Key 047-06754-0000
 - Battery Eliminator 071-05087-0000
 - Spline Wrench .48 071-06119-0000
 - Spanner 076-01451-0000
 - Accessory Test Cable 155-02260-0000
 - RF Cable Assembly 155-02268-0000
 - Audio Cable Assembly 155-02269-0000
- J. Test Cable Kit LAA0608, P/N 050-02767-0000.
This cable kit consists of the following parts:
 - Eight-pin interconnect cable 155-02528-0000.
 - Ten-pin interconnect cable 155-02564-0000.
 - Twelve-pin interconnect cable 155-02565-0000.
 - RF Output interconnect cable 155-02566-0000.
 - Local Oscillator cable 155-02567-0000.

5.3 OVERHAUL

5.3.1 VISUAL INSPECTION

This section contains instructions to assist in determining, by inspection, the condition of EPH assemblies. Defects resulting from wear, physical damage, deterioration, or other causes can be found by these inspection procedures. To aid inspection, detailed procedures are arranged in alphabetical order.

A. CAPACITORS, FIXED

Inspect capacitors for case damage, body damage, and cracked, broken, or charred insulation. Check for loose, broken, or corroded terminal studs, lugs, or leads. Inspect for loose, broken, or improperly soldered connections. On chip caps be especially alert for hairline cracks in the body and broken terminations.

B. CAPACITORS, VARIABLE

Inspect trimmers for chipped and cracked bodies, damaged dielectrics and damaged contacts.

C. CHASSIS

Inspect the chassis for deformation, dents, punctures, badly worn surfaces, damaged connectors, damaged fastener devices, loose or missing hardware, component corrosion, and damage to the finish.

D. CONNECTORS

Inspect connectors for broken parts, and other irregularities. Inspect for cracked or broken insulation and for contacts that are broken, deformed, or out of alignment. Also, check for corroded or damaged plating on contacts and for loose, improperly soldered, broken, or corroded terminal connections.

E. COVERS AND SHIELDS

Inspect covers and shields for punctures, deep dents, and badly worn surfaces. Also, check for damaged fastener devices, corrosion and damage to finish.

F. FLEX CIRCUITS

Inspect flex circuits for punctures, and badly worn surfaces. Check for broken traces, especially near the solder contact points.

G. FUSE

Inspect for blown fuse and check for loose solder joints.

H. INSULATORS

Inspect insulators for evidence of damage, such as broken or chipped edges, burned areas, and presence of foreign matter.

I. JACKS

Inspect all jacks for corrosion, rust, deformations, loose or broken parts, cracked insulation, bad contacts, or other irregularities.

J. POTENTIOMETERS

Inspect all potentiometers for evidence of damage or loose terminals, cracked insulation or other irregularities.

K. RESISTORS, FIXED

Inspect the fixed resistors for cracked, broken, blistered, or charred bodies and loose, broken, or improperly soldered connections. On chip resistors be especially alert for hairline cracks in the body and broken terminations.

L. RF COILS

Inspect all RF coils for broken leads, loose mountings, and loose, improperly soldered, or broken terminal connections. Check for crushed, scratched, cut or charred windings. Inspect the windings, leads, terminals and connections for corrosion or physical damage. Check for physical damage to forms and tuning slug adjustment screws.

M. TERMINAL CONNECTIONS SOLDERED

1. Inspect for cold-soldered or resin joints. These joints present a porous or dull, rough appearance. Check for strength of bond using the points of a tool.
2. Examine the terminals for excess solder, protrusions from the joint, pieces adhering to adjacent insulation, and particles lodged between joints, conductors, or other components.
3. Inspect for insufficient solder and unsoldered strands of wire protruding from conductor at the terminal. Check for insulation that is stripped back too far from the terminal.
4. Inspect for corrosion at the terminal.

N. WIRING/COAXIAL CABLE

Inspect wiring in chassis for breaks in insulation, conductor breaks, cut or broken lacing and improper dress in relation to adjacent wiring or chassis.

5.3.2 CLEANING

- A. Using a clean, lint-free cloth lightly moistened with soap and water only, remove the foreign matter from the equipment case and unit front panel. Wipe dry using a clean, dry, lint-free cloth.
- B. Using a hand controlled dry air jet (not more than 15psi), blow the dust from inaccessible areas. Care should be taken to prevent damage by the air blast.
- C. Clean the receptacles and plugs with a hand controlled dry air jet (not more than 25psi), and a clean, lint-free cloth lightly moistened with soap and water only. Wipe dry with a clean, dry, lint-free cloth.

5.3.3 REPAIR

This section describes the procedure along with any special techniques for replacing damaged or defective components.

A. CONNECTORS

When replacing a connector, refer to the appropriate PC board assembly drawing and follow the notes to insure correct mounting and mating of each connector.

B. CRYSTAL

The use of any other than a BENDIX/KING crystal is considered an unauthorized modification.

C. DIODES

Use long nose pliers as a heat sink under normal soldering conditions. Note the diode polarity before removal.

D. INTEGRATED CIRCUITS

Refer to Appendix A for removal and replacement instructions.

E. WIRING/COAXIAL CABLE

When repairing a wire that has broken from its terminal, remove all old solder and pieces of wire from the terminal, restrip the wire to the necessary length and resolder the wire to the terminal. Replace a damaged wire or coax with one of the same type, size and length.

5.4 DISASSEMBLY/ASSEMBLY

5.4.1 BATTERY REMOVAL

To remove the battery pack, turn the radio off. Press up the metal tab on the side of the case while turning the pack approximately 30°. Remove the pack from the radio.

5.4.2 UNIT DISASSEMBLY

1. Remove the four screws from the radio rear cover (the side opposite the speaker grill).
2. Remove the two screws holding the heat sink shield to the rear cover and remove the heat sink shield.
3. Loosen the PTT housing screw and separate the front cover from the main frame.

A. OPTIONS BOARD AND KEYBOARD

- A. Disconnect the zero force insertion connector (J 10) from the options board, by sliding the connector sleeve toward the top of the radio. This allows the flex cable to be unplugged.
- B. Remove the five screws that secure the options board to the keyboard and the front cover, unplug the keyboard.

B. RX/TX BOARD

- A. Unfasten the three retaining clip screws that secure the RX/TX board to the main frame.
- B. Carefully remove the antenna coax from the RX/TX connector.
- C. Lift up on the RX/TX board until it is disconnected from the systems board.

C. SYNTHESIZER AND VCO

Remove the screw and unsolder the 5 tabs that secure the Synthesizer shield to the systems board. Remove the shield halves from both sides of the systems board.

D. TOP PLATE AND SWITCH BOARD

- A. Remove the channel select, volume, and the squelch knobs.
- B. Remove the retaining fasteners from the channel select switch, volume control, and the squelch control.
- C. Remove the bezel and inlay, retaining the channel select stop pins.
- D. Remove the retaining fasteners from the talk around, scan, and priority switches.
- E. Unfasten the four screws that secure the top frame assembly to the main frame (the screws are located on the side of the frame, two screws beside the channel select switch and two screws below the PTT housing).
- F. Unsolder the audio jack wire from systems board location E13.

5.4.3 ASSEMBLY

To assemble the unit complete the disassembly procedure in reverse order.

5.5 TEST AND ALIGNMENT PROCEDURES

5.5.1 TEST SET-UP

The radio should be supplied with 10.5 VDC power from an external power supply, and the manual controls shall be set as follows:

Channel Selector:	Channel 1
On/Off Volume:	On, Volume minimum
Squelch/Monitor:	Unsquelled, Fully Clockwise
High / Low power:	High power
Scan:	Off
Priority:	Off
Battery Saver:	Off

The radio should be mounted in a suitable fixture containing an adaptor for supplying DC power from an external power supply.

Refer to Figures 5-2 and 5-3 for Transmitter and Receiver test setup. These figures show the interface between test equipment and the radio.

5.5.2 SYNTHESIZER

A. VCO ADJUSTMENT

1. The radio should be programmed with 148 and 174 MHz.
2. Set the radio to receive on 148 MHz.
3. Connect a digital voltmeter between TPE16 and ground.
4. Adjust T1 for a reading of 2.0 VDC with the synthesizer locked.
5. Set the radio to receive at 174 MHz. The voltage at TPE16 should be less than 7.6 VDC.

B. REFERENCE OSCILLATOR ADJUSTMENT

1. Connect a service monitor to the output of the transmitter.
2. Set the radio for any valid transmit frequency and set the service monitor to receive on this frequency.
3. Key the transmitter and adjust C6 on the systems board to obtain the frequency selected within 200 Hz.

C. DEVIATION ADJUSTMENT

1. Connect the antenna output to the RF input jack of the service monitor.
2. Connect the modulation output of the service monitor to the Mic high input of the radio. Connect the digital multimeter to monitor this input voltage.
3. Adjust the audio output level of the modulation output to 0.15 VRMS at a frequency of 1 kHz.
4. Set the service monitor to receive this transmitter frequency.
5. Adjust R3 on the systems board to the center of its range.
6. Key the transmitter and adjust R40 on the systems board to obtain a deviation reading of 4.75 kHz on the service monitor.
7. Check the deviation reading on all of the other transmit frequencies. On any frequency where the deviation is greater than 5 kHz, adjust to reduce the deviation to 5 kHz.

D. REFERENCE MODULATION ADJUSTMENT

1. Adjust the modulation output level from the service monitor to 0 volts.
2. Key the transmitter and observe the resulting waveform on the service monitor display.
3. Adjust R3 on the systems board to obtain the flattest waveform possible. A droop of up to 30% is allowable.
4. Return the modulation output level from the service monitor to 0.15 VRMS, and readjust the deviation if necessary.

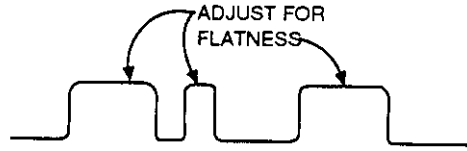

FIGURE 5-1 REFERENCE MODULATION ADJUSTMENT

5.5.3 TRANSMITTER

NOTE: Adjustments of the high and low transmitter power settings, as well as the receiver tuning slope, can be made using a computer, EPH RX/TX Tuning software, and a programming cable. Specific instructions are provided in the EPH RX/TX Tuning software manual.

A. HIGH POWER ADJUSTMENT

1. Connect the RF power meter and 50 ohm load to the RF output side connector.
2. Set the radio to the highest available transmit frequency with high power enabled.
3. Key the transmitter and record the output power.
4. Adjust the transmitter high power setting using a computer, EPH RX/TX Tuning software, and a programming cable.
5. Repeat the above steps until 5 watts is obtained.
6. Retest at frequencies near midband and 148 MHz. Increase the output power if below 5 Watts.

B. LOW POWER ADJUSTMENT

1. Connect the RF power meter and 50 ohm load to the RF output side connector.
2. Set the radio to the lowest available transmit frequency with low power enabled.
3. Key the transmitter and record the output power.
4. Adjust the transmitter low power setting using a computer, EPH RX/TX Tuning software, and a programming cable.
5. Repeat the above steps until 1.5 Watts is obtained.
6. Retest at frequencies near midband and 174 MHz. Adjust the output power if below 1.4 or above 2.45 Watts.

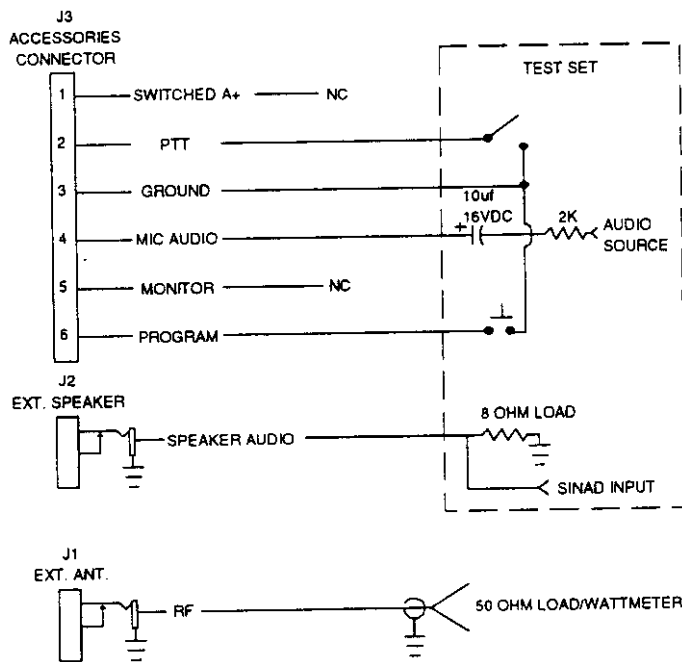
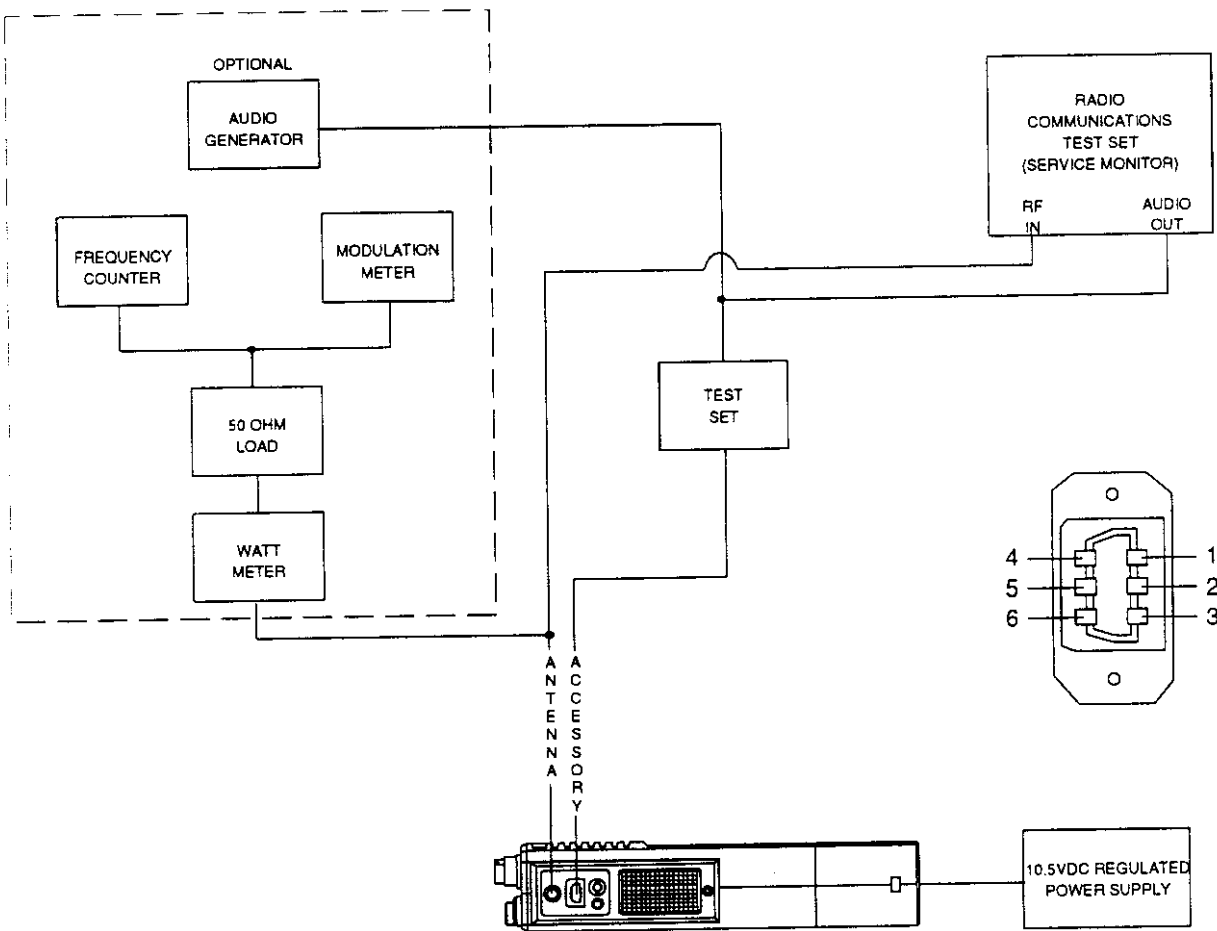
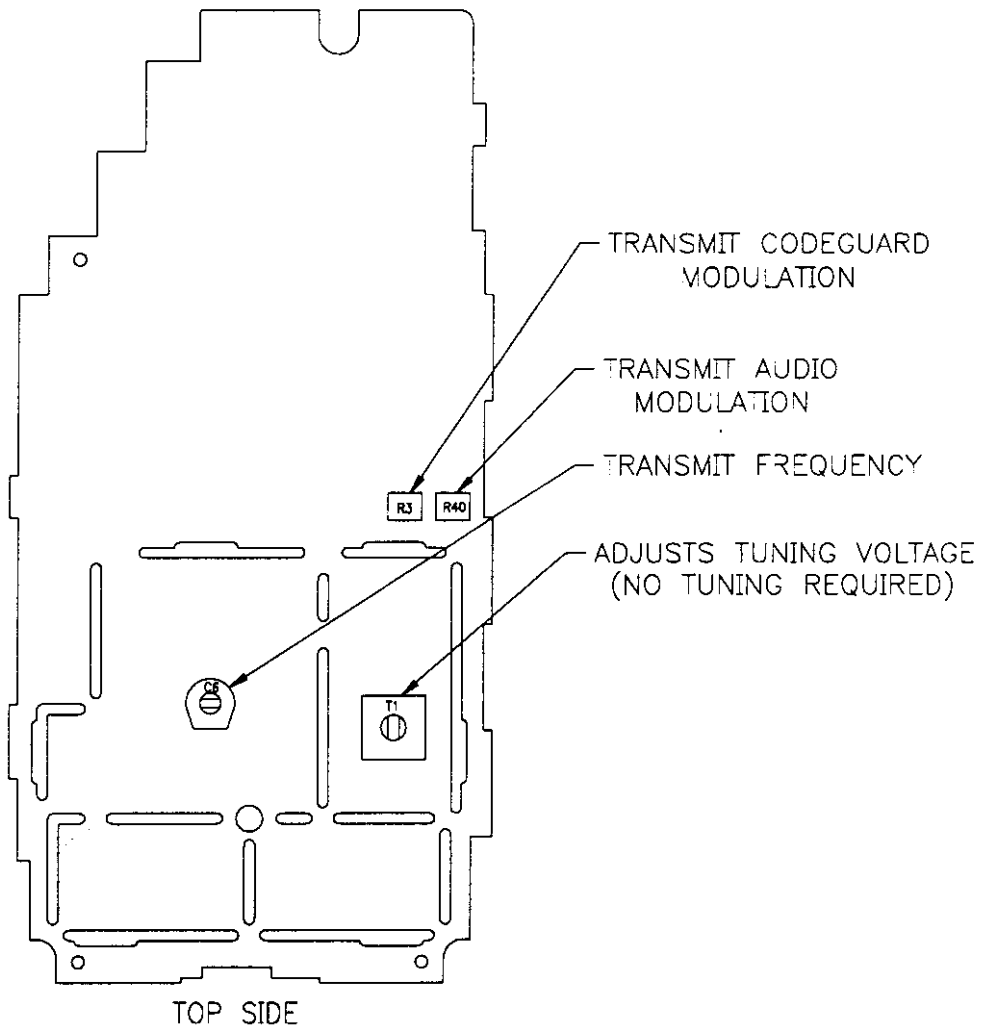
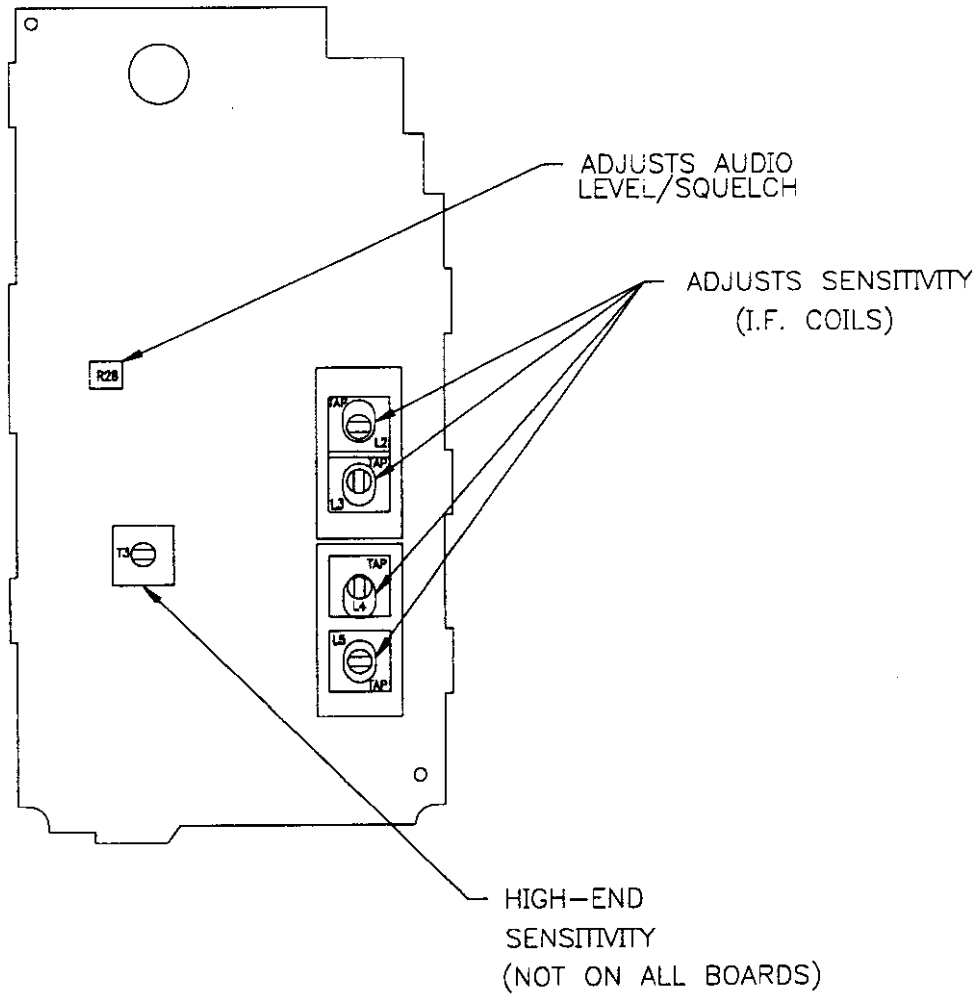

FIGURE 5-2 TRANSMITTER TEST SET-UP



SYSTEMS BOARD ADJUSTMENTS



RX/TX BOARD ADJUSTMENTS

5.5.4 RECEIVER

A. FRONT END TUNING

1. The radio should be programmed with 148 and 174 MHz. Select 174 MHz. Open the squelch. Adjust the volume control to mid range.
2. Set the RF signal generator to 174 MHz. Adjust modulation for a 1000 Hz tone with 3000 Hz deviation.
3. Connect the RF generator to the RF input. Connect a distortion analyzer to the speaker audio output.
4. Increase the RF level until 6 to 12 dB SINAD is observed on the distortion analyzer.
5. Adjust L2, L3, L4, and L5 alternately to obtain the best SINAD reading while reducing the RF input level to maintain 6 to 12 dB SINAD.
6. Adjust the front end slope variable using a computer, EPH RX/TX Tuning software, and a programming cable.

NOTE: Because of RF interference from the computer, the radio may not meet the sensitivity specifications until disconnected and removed from the immediate vicinity of the computer.

7. Adjust T1 and T2 for the lowest audio distortion with an RF input level of 1 mVRMS. Note that T3 will have little affect on the tuning. T1 and T2 exhibit two peaks as the core is rotated into the coil. Preset the cores to the top of the coil before making the adjustment. When adjusted for lowest distortion, the top of the core should be in the upper half of the coil. This will prevent coil breakage. Note also that if T3 is adjusted to the bottom then loading of the LO may occur which can affect output power or synthesizer locking at some frequencies.

B. SQUELCH ADJUSTMENT

1. Set the radio to a channel programmed with no guard enabled.
2. Open the squelch. Adjust volume control to a medium position.
3. Connect the RF generator to the RF input. Connect a distortion analyzer to the speaker audio output.
4. Increase the RF level until 8 dB SINAD is observed on the distortion analyzer.
5. Set the radio squelch knob to the Code Guard position (on the detent).
6. Turn R28 on the RX/TX board clockwise until the audio turns off.
7. Turn R28 slowly counterclockwise until the audio turns on.

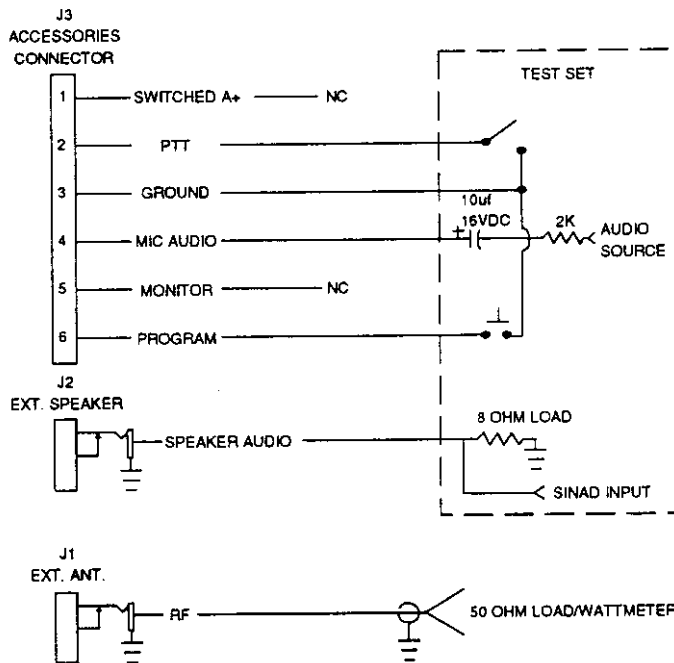
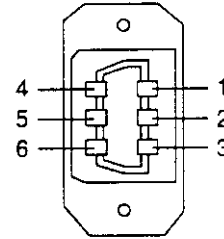
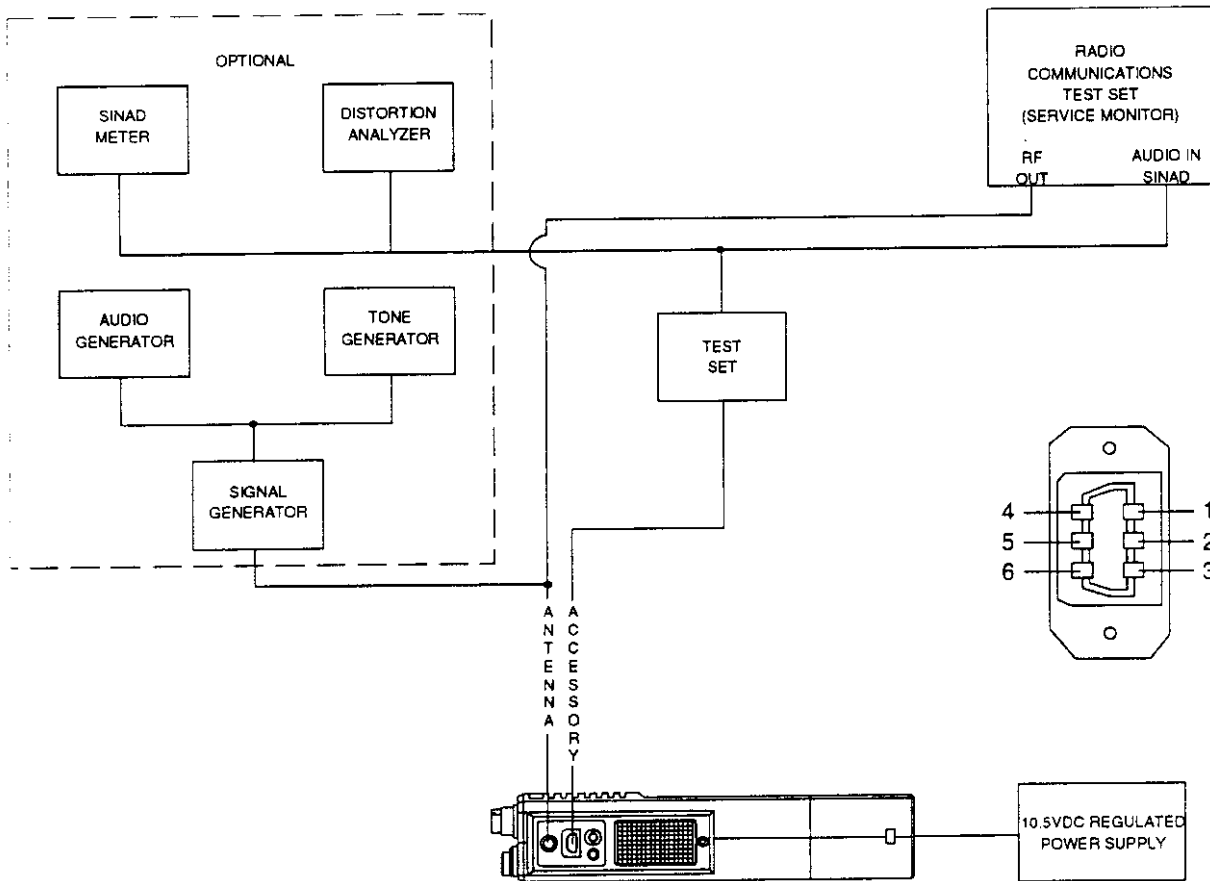

FIGURE 5-3 RECEIVER TEST SET-UP

5.6 TROUBLESHOOTING

Radio will not transmit (Red LED does not light)	Invalid TX frequency programmed Weak battery VCO TX bandshift circuit failing Open PTT path to microprocessor Broken PTT switch
Radio will not turn on	Exhausted battery Open fuse Broken on/off switch Failing 5 volt regulator Improper information in EEPROM
Radio will not unmute	Invalid RX frequency programmed Internal squelch trimmer adjusted improperly CARRIER PRESENT signal to microprocessor shorted or open Audio amplifier failing DISC AUDIO path open or shorted RX AUDIO path open or shorted
Transmit power below specification	Software power adjustment incorrect HI/LO switch shorted RF side connector jack failing Harmonic filter failing Power amplifier failing Power control circuit failing Antenna switch failing VCO buffer failing
Code Guard signal not being transmitted	No Code Guard signal programmed on transmit channel Code Guard buffer (I4, I14, RN1) failing
Poor battery life	Transmitter power adjusted too high Battery saver not programmed Audio amplifier not switching off Weak battery
Will not enter keyboard programming mode	Improper password being entered Open or shorted -PROGRAM signal Keyboard / Display unit failing Invalid hardware data in the EEPROM
Radio unmutes with no carrier present when in preset condition	Squelch trimmer adjusted improperly Open or shorted CARRIER PRESENT signal
Radio does not unmute when proper Code Guard signal is present	Tone filter on options board failing Code Guard clipper failing
Sensitivity does not meet specification	Front end filters misaligned or failing Software front end tuning adjusted improperly RF amplifier failing IF filter or amplifier failing VCO buffer failing
Receiver distortion out of specification	IF transformers mistuned (Adjustable models only) Audio amplifier failing Receiver audio filter on options board failing

Low or no transmitter audio modulation	TX audio trimmer misadjusted Microphone failing TX audio amplifier/filter chain on options board failing VCO modulation circuit failing
TX modulation is too high	TX audio trimmer misadjusted Deviation compensation network (R42 thru R45 on systems board) failing VCO modulation circuit failing
Audio output power does not meet specification	Squelch trimmer on RX/TX board adjusted improperly Audio power amplifier failing Audio filter on options board failing FM demodulator IC failing
Transmitted digital Code Guard will not unqueich other radios	DCG not programmed or not set for proper polarity Reference modulation trimmer adjusted improperly Reference modulation circuit (CR1 and CR2) failing
Radio always gives low battery indication (flashing LED and "Lobat" message displayed)	Failing or shorted 8.2 volt regulator
Radio will not function properly at band edges	VCO tuning voltage (T1) misadjusted Shorted or open HI BAND signal to synthesizer loop amplifier
Transmitter frequency out of 5 ppm specification	XTAL frequency misadjusted Failing temperature compensation network on systems board Failing XTAL
ANI or DTMF tones not being transmitted	Radio not programmed for ANI or DTMF Tone path to I9 from RN1 on systems board shorted or open
Transmitter modulation varying across frequency band	Failing compensation network (R42 through R45 on systems board)
Audio opening without receiving the programmed Code Guard	Monitor switch failing Monitor switch buffer (I5 on systems board) failing
Insufficient transmit range	Improper antenna for VHF frequencies Open antenna jack Failing antenna match circuit

SECTION VI ILLUSTRATED PARTS LIST

6.1 INTRODUCTION

This section helps you identify parts used in BENDIX/KING EPH Series portable VHF radios. It includes Bills Of Material (BOM) for all major assemblies arranged from Final Assembly down to individual part level. Each BOM is followed by the corresponding Assembly Drawing and Schematic Diagram.

Parts listed in the BOMs meet BENDIX/KING design specifications and are the recommended replacement parts.

6.2 BILLS OF MATERIAL

Bills of Material contain specific information on each part in the corresponding Assembly Drawing and Schematic Diagram. Sub-assemblies are listed by BOM number, helping you find the correct sub-assembly parts for each specific radio model.

BOM NUMBER

The Bill of Material Number, which is also the 12-digit Part Number for the assembly, appears at the top of the BOM. If the assembly is available in a variety of "flavors", the BOM Number for each flavor appears at the top of the BOM. Parts common to more than one flavor are often listed in a Common BOM, ending with -0099. The last four digits of each BOM Number appear above a flavor column at the right side of the BOM.

SYMBOL COLUMN

This column contains the Reference Designators of parts as labelled in the Assembly Drawing and Schematic Diagram. The Reference Designator consists of an abbreviation for type of component and a number assigned to that part (ITM 4, R 31, etc). Common Reference Designator abbreviations are listed below.

ASY	Assembly	MK	Microphone
B	Motor or Synchro	P	Plug
C	Capacitor	Q	Transistor
CJ	Circuit Jumper	R	Resistor
CR	Diode	REF	Reference
DS	Lamp	RN	Resistor Network
F	Fuse	RT	Thermistor
FL	Filter	S	Switch
I	Integrated Circuit	T	Transformer
ITM	Item	TP	Test Point
J	Jack	U	Resistor/Capacitor Network
L	Inductor	V	Photocell/Vacuum Tube
LS	Speaker	WG	Waveguide
M	Meter	Y	Crystal

PART NUMBER COLUMN

This column contains the individual Part Numbers used when ordering replacement parts. If the part is listed as an assembly (ASY), the BOM and drawings for that assembly follow after the current BOM and drawings.

DESCRIPTION COLUMN

This column contains the description of each part in the assembly. Common abbreviations which may appear in this column are listed below.

AL	Aluminum	MY	Mylar
ASSY	Assembly	PC	Polycarbonate
BIFLR	Bifilar	PF	Precision Film
BOM	Bill of Material	PP	Paper
CC	Carbon Composite	PS	Polystyrene
CF	Carbon Film	QW	Quarter Watt
CH	Choke	RES	Resistor
CAP	Capacitor	S	Silicon
CR	Ceramic	SCR	Screw
DC	Disc Ceramic	SM	Silver Mica
DIO	Diode	STDF	Standoff
EL	Electrode	SW	Switch
EW	Eighth Watt	TERM	Terminal
FC	Fixed Composition	TN	Tantalum
FERR	Ferrite	TST PT	Test Point
FLTR	Filter	TW	Tenth Watt
FT	Feedthru	VA	Variable
HV	High Voltage	WW	Wire Wound
HW	Half Watt	XFMR	Transformer
IC	Integrated Circuit	XSTR	Transistor
MC	Monolithic Ceramic	XTAL	Crystal

ASSEMBLY COLUMN

An "A" in this column indicates that the part is an assembly. If the P/N and description reads "200-0XXXX-0099 COMMON BOM" the parts for that assembly are included in the current BOM. The parts breakdown for an assembly with any other P/N will be found in the BOM with the same number. Those assemblies with BOMs and drawings included in this manual are indicated by "ASY" in the Symbol Column.

UNIT OF MEASURE (UM) COLUMN

This column indicates the Unit of Measure for each part. Common abbreviations found in this column are listed below.

EA	Each	RF	For Reference Only
FT	Foot	IN	Inch
AR	As Required		

QUANTITY COLUMNS

These columns indicate the part quantities for each flavor of the assembly. The four-digit number above each column corresponds to the last four digits of a BOM Number at the top of the BOM. Parts common to more than one flavor are often listed in Common BOMs, ending with -0098 or -0099.

FINAL ASSEMBLY

062-00137-0000 EPH 502 0A
 062-00137-0001 EPH 514 0A
 062-00137-0002 EPH 514 1A
 062-00137-0003 EPH 542 1A
 062-00137-0004 EPH 599 1A
 062-00137-0005 EPH 599 1K
 062-00137-0006 EPH 599 SL
 062-00137-0007 EPH 514 2A
 062-00137-0008 EPH 514 0M
 062-00137-0009 EPH 514 2M

SYMBOL	PART NUMBER	DESCRIPTION	A	UM	QUANTITY										
					0000	0001	0002	0003	0004	0005	0006	0007	0008	0009	
	062-00137-0004	FINAL ASSY	A	EA			1.00	1.00							
	062-00137-0011	FINAL ASSY	A	EA									1.00		
	062-00137-0099	FINAL ASSY COMMON	A	EA	1.00	1.00			1.00	1.00	1.00			1.00	1.00
ASY 1	200-05042-0000	EPH R/T	A	EA	1.00	1.00			1.00	1.00	1.00			1.00	1.00
ASY 2	200-03477-0004	FT CVR W/O KYBD	A	EA										1.00	
ASY 2	200-03477-0006	FRONT CVR	A	EA	1.00	1.00									
ASY 2	200-03477-0007	FRONT CVR W/KBD	A	EA					1.00	1.00					
ASY 2	200-03477-0009	EPH CVR W/ALPHA	A	EA							1.00				
ASY 2	200-03477-0021	EPH METAL W/ALPHA	A	EA											1.00
ASY 3	200-05039-0000	SYS/FRAME ASSY	A	EA	1.00										1.00
ASY 3	200-05039-0001	SYS/FRAME ASSY	A	EA		1.00									
ASY 3	200-05039-0004	SYS/FRAME ASSY	A	EA				1.00			1.00				
ASY 3	200-05039-0005	SYS/FRM ASSY	A	EA						1.00					
ASY 3	200-05039-0006	SYS/FRM ASSY	A	EA									1.00		
ASY 3	200-05039-0007	SYS/FRM ASSY	A	EA											1.00
ITM 2	073-00609-0004	MOD COVER	A	EA										1.00	1.00
ITM 2	088-02078-0010	BACK CVR METAL 2W	A	EA	1.00	1.00			1.00	1.00	1.00				
ITM 3	089-07070-0003	SCR BHC 4-40X3/16		EA		1.00	1.00			1.00	1.00	1.00			1.00
ITM 8	088-02089-0000	PLATE	A	EA	1.00	1.00			1.00	1.00	1.00			1.00	1.00
ITM 10	089-07074-0005	SCR FHP M2.5X5.0	A	EA	2.00	2.00			2.00	2.00	1.00			2.00	1.00
ITM 15	016-01013-0000	VAC GREASE DC 976		AR										1.00	1.00
ITM 16	187-01331-0000	TEFLON CORD GASKET		IN										7.00	7.00
ITM 17	091-00187-0001	WASHER SHOULDER		EA										4.00	4.00
ITM 18	187-01333-0000	HEAT SINK GASKET		EA										1.00	1.00
ITM 19	195-00137-0000	SFTWR OPTIONS	A	EA						1.00					

FINAL ASSEMBLY

- 062-00137-0010 EPH 599 SM
- 062-00137-0011 EPH 599 2A
- 062-00137-0012 EPH 599 2D
- 062-00137-0013 EPH 599 DM
- 062-00137-0014 EPH 514 1M
- 062-00137-0015 EPH 599 1M
- 062-00137-0020 EPH 214 2A
- 062-00137-0099 COMMON BOM

SYMBOL	PART NUMBER	DESCRIPTION	A	UM	QUANTITY						
					0010	0011	0012	0013	0014	0015	0020

	006-01203-0000	EPH OWNERS MANUAL	A	EA									1.00
	062-00137-0015	FNL ASSY EPH 5991M	A	EA					1.00				
	062-00137-0099	FINAL ASSY COMMON	A	EA	1.00	1.00	1.00	1.00		1.00	1.00		
ASY 1	200-05042-0000	EPH R/T	A	EA	1.00	1.00				1.00			
ASY 1	200-05042-0001	EPH R/T DES	A	EA							1.00		
ASY 1	200-05042-0050	EPH R/T DES	A	EA			1.00	1.00					
ASY 2	200-03477-0005	FRT CVR W/KYBD	A	EA						1.00			
ASY 2	200-03477-0008	EPH CVR W/ALPHA	A	EA							1.00		
ASY 2	200-03477-0010	A-N E STD OPT	A	EA		1.00							
ASY 2	200-03477-0022	EPH METAL W/ALPHA	A	EA	1.00								
ASY 2	200-03477-0023	NM E DES	A	EA			1.00						
ASY 2	200-03477-0024	NM E MTL DES	A	EA				1.00					
ASY 3	200-05039-0001	SYS/FRAME ASSY	A	EA							1.00		
ASY 3	200-05039-0004	SYS/FRAME ASSY	A	EA		1.00							
ASY 3	200-05039-0008	SYS/FRM ASSY	A	EA	1.00					1.00			
ASY 3	200-05039-0010	SYS FRM DES MTL	A	EA			1.00	1.00					
ITM 1	076-01440-0000	STANDOFF 550		EA									1.00
ITM 2	073-00609-0004	MOD COVER	A	EA	1.00			1.00		1.00			
ITM 2	088-02078-0010	BACK CVR METAL 2W	A	EA		1.00	1.00						
ITM 2	088-02078-0016	BACK CVR METAL 2W	A	EA							1.00		
ITM 3	089-07070-0003	SCR BHC 4-40X3/16		EA	1.00	1.00	1.00	1.00		1.00			
ITM 4	089-07071-0023	SCR PHP M2.5X23	A	EA									1.00
ITM 5	012-01494-0000	INSULATOR SYS BD		EA									1.00
ITM 6	047-08958-0001	CLIP 256W/FIN		EA									3.00
ITM 7	076-01466-0000	STANDOFF		EA									1.00
ITM 8	088-02089-0000	PLATE	A	EA	1.00	1.00	1.00	1.00		1.00			
ITM 9	089-06004-0003	SCR FHP 2-56X3/16		EA									3.00
ITM 10	089-07074-0005	SCR FHP M2.5X5.0	A	EA	2.00	2.00	2.00	2.00		2.00			
ITM 11	089-07071-0008	SCR PHP M2.5X8	A	EA									2.00
ITM 12	089-07071-0035	SCR PHP M2.5X35	A	EA									1.00
ITM 13	195-00018-0000	FCC DECAL OPTIONS	A	EA									1.00
ITM 14	016-01134-0003	COPPER TAPE	A	IN									0.75
ITM 15	016-01013-0000	VAC GREASE DC 976		AR	1.00			1.00		1.00			
ITM 16	187-01331-0000	TEFLON CORD GASKET		IN	7.00			7.00		7.00			
ITM 17	091-00187-0001	WASHER SHOULDER		EA	4.00			4.00		4.00			
ITM 18	187-01333-0000	HEAT SINK GASKET		EA	1.00			1.00		1.00			
REF 1	300-05038-0000	FINAL ASSY EPH	A	RF									X
REF 2	002-01004-0000	SCH INTERCONNECT	A	RF									X

SYSTEMS FRAME ASSEMBLY

200-05039-0000 EPH 502 0A
 200-05039-0001 EPH 214 2A, 514 0A
 200-05039-0002 EPH 514 1A, 514 2A
 200-05039-0003 EPH 542 1A
 200-05039-0004 EPH 599 1A, 599 SL, 599 2A
 200-05039-0005 EPH 599 1K
 200-05039-0006 EPH 514 0M
 200-05039-0007 EPH 514 2M
 200-05039-0008 EPH 599 SM
 200-05039-0009 EPH 499 2D, 499 DM

SYMBOL	PART NUMBER	DESCRIPTION	A	UM	QUANTITY										
					0000	0001	0002	0003	0004	0005	0006	0007	0008	0009	
	200-05039-0099	COMMON BOM	A	EA	1.00	1.00	1.00	1.00	1.00	1.00	1.00	1.00	1.00	1.00	
ASY 1	200-08291-0000	EPH SYS 14 CH	A	EA	1.00	1.00	1.00				1.00	1.00			
ASY 1	200-08291-0001	EPH SYS 42 CH	A	EA				1.00							
ASY 1	200-08291-0002	EPH SYS 210 CH	A	EA					1.00	1.00			1.00		
ASY 1	200-08291-0050	EPH SYS DES	A	EA										1.00	
ASY 2	200-06909-0001	CTRL BD 14CH WK	A	EA			1.00	1.00	1.00			1.00	1.00		
ASY 2	200-06909-0002	CTRL BD 2 CH 4W	A	EA	1.00										
ASY 2	200-06909-0004	CTRL BD EPH	A	EA		1.00					1.00				
ASY 2	200-06909-0005	CTRL BD TEXAS EPH	A	EA						1.00					
ASY 2	200-06909-0050	CTRL BD DES	A	EA										1.00	
ASY 3	200-03475-0002	TOP FRAME ASSY	A	EA	1.00	1.00	1.00	1.00	1.00	1.00				1.00	
ASY 3	200-03475-0003	TOP FRM ASSY	A	EA							1.00	1.00	1.00		
ITM 13	047-07465-0000	WSHR CHNL SLCT		EA	1.00	1.00	1.00	1.00	1.00		1.00	1.00	1.00	1.00	
ITM 14	076-01461-0000	SPACER SWITCH		EA	1.00	2.00	3.00	3.00	3.00	1.00	2.00	3.00	3.00	3.00	
ITM 15	076-01439-0000	NUT SLOT M5X0.50		EA	1.00	2.00	3.00	3.00	3.00	1.00	2.00	3.00	3.00	3.00	
ITM 16	088-01311-0000	LED BUSHING		EA		1.00	1.00	1.00	1.00	1.00	1.00	1.00	1.00		
ITM 17	057-03551-0009	TOP INLAY		EA	1.00										
ITM 17	057-03551-0011	INLAY SPECIAL		EA		1.00					1.00				
ITM 17	057-03551-0012	INLAY SPECIAL		EA			1.00	1.00	1.00			1.00	1.00		
ITM 17	057-03551-0016	TOP INLAY	A	EA										1.00	
ITM 17	057-03551-0019	TOP INLAY	A	EA						1.00					
ITM 20	088-02052-0001	SWITCH BEZEL W/DCR	A	EA		1.00	1.00	1.00	1.00		1.00	1.00	1.00	1.00	
ITM 20	088-02072-0001	SW BZL 2CH W/DCR	A	EA	1.00										
ITM 21	090-00492-0000	PIN DOW .047X.165	A	EA		2.00	2.00	2.00	2.00		2.00	2.00	2.00	2.00	
ITM 22	076-01439-0002	NUT SLOT 1/4-40		EA	1.00	1.00	1.00	1.00	1.00		1.00	1.00	1.00	1.00	
ITM 23	088-02085-0001	CHANNEL KNOB MLED	A	EA	1.00	1.00	1.00	1.00	1.00		1.00	1.00	1.00	1.00	
ITM 31	088-01301-0000	ANTENNA BUSHING		EA	1.00	1.00	1.00	1.00	1.00	1.00	1.00	1.00	1.00	1.00	
ITM 32	088-01310-0000	ANTENNA NUT		EA	1.00	1.00	1.00	1.00	1.00	1.00	1.00	1.00	1.00	1.00	
ITM 35	088-02058-0000	SWITCH BOOT		EA			1.00	1.00	1.00			1.00	1.00		
ITM 35	088-02058-0001	SWITCH BOOT		EA		1.00				1.00	1.00				
ITM 35	088-02058-0003	SWITCH BOOT		EA	1.00										
ITM 35	088-02058-0007	SWITCH BOOT		EA										1.00	
ITM 42	187-01321-0000	GSKT_LTCH PLT HSG		EA							1.00	1.00	1.00		
ITM 43	012-01421-0000	MICROTHIN TAPE		IN							2.00	2.00	2.00		
ITM 44	035-08373-0002	SEALING TAPE TAN	A	IN							0.50	0.50	0.50		
ITM 45	016-01013-0000	VAC GREASE DC 976		AR							1.00	1.00	1.00		
ITM 46	088-03016-0000	SPACER	A	EA						1.00					
REF 1	300-05039-0010	MOD SYS FRAME ASSY	A	RF							X	X	X		

SYSTEMS FRAME ASSEMBLY

200-05039-0010 EPH 599 2D 599 DM
 200-05039-0099 COMMON BOM

SYMBOL	PART NUMBER	DESCRIPTION	A	UM	QUANTITY
					0010 0099
	200-05039-0099	COMMON BOM	A	EA	1.00
ASY 1	200-08291-0050	EPH SYS DES	A	EA	1.00
ASY 2	200-06909-0050	CTRL BD DES	A	EA	1.00
ASY 3	200-03475-0003	TOP FRM ASSY	A	EA	1.00
C 1	111-00001-0015	CAP CR 330PF 50V		EA	1.00
C 2	109-00012-0001	CAP DC 4.7PF 100V		EA	1.00
F 1	036-00057-0009	FUSE 275 125V 4A		EA	1.00
ITM 1	089-07394-0000	SCR FHP 2-56X9/32	A	EA	4.00
ITM 2	047-06702-0000	BTRY LATCH PLATE		EA	1.00
ITM 3	076-01446-0000	POSITIVE CONTACT		EA	1.00
ITM 4	089-08335-0000	WSHR CURVED SPRING	A	EA	1.00
ITM 5	010-00019-0093	TERM STDF WHT	A	EA	2.00
ITM 6	088-01304-0010	LTCH PLT HSG MOD	A	EA	1.00
ITM 7	047-06703-0000	LATCH SPRING	A	EA	1.00
ITM 8	090-00019-0000	RING RTNR .125		EA	1.00
ITM 9	026-00030-0000	WIRE CU24AWG TIN	A	IN	0.50
ITM 10	047-07476-0003	LOWER FRAME	A	EA	1.00
ITM 11	047-07479-0003	SIDE FRAME	A	EA	1.00
ITM 12	089-06004-0002	SCR FHP 2-56X1/8		EA	3.00
ITM 13	047-07465-0000	WSHR CHNL SLOTT		EA	1.00
ITM 14	076-01461-0000	SPACER SWITCH		EA	3.00
ITM 15	076-01439-0000	NUT SLOT M5X0.50		EA	3.00
ITM 17	057-03551-0016	TOP INLAY	A	EA	1.00
ITM 18	076-01439-0001	NUT SLOT M6X0.70		EA	2.00
ITM 19	088-02087-0001	KNOB MOLDED	A	EA	2.00
ITM 20	088-02052-0001	SWITCH BEZEL W/DCR	A	EA	1.00
ITM 21	090-00492-0000	PIN DOW .047X .165	A	EA	2.00
ITM 22	076-01439-0002	NUT SLOT 1/4-40		EA	1.00
ITM 23	088-02085-0001	CHANNEL KNOB MLED	A	EA	1.00
ITM 24	025-00001-0002	WIRE 26 RED		IN	6.50
ITM 26	047-09518-0000	LOWER LID ASSY	A	EA	1.00
ITM 27	047-09519-0000	TOP LID ASSY	A	EA	1.00
ITM 28	089-05895-0006	SCR PHP 0-80X3/8	A	EA	1.00
ITM 31	088-01301-0000	ANTENNA BUSHING		EA	1.00
ITM 32	088-01310-0000	ANTENNA NUT		EA	1.00
ITM 33	088-02067-0001	TOP PLT SPEC	A	EA	1.00
ITM 34	187-01755-0000	O-RING	A	EA	1.00
ITM 35	088-02058-0007	SWITCH BOOT		EA	1.00
ITM 36	089-06004-0003	SCR FHP 2-56X3/16		EA	1.00
ITM 37	016-01124-0005	FOAM TAPE		IN	0.50
ITM 38	150-00104-0004	TBG HT SHRNK 3/32		IN	0.25
ITM 39	016-01412-0000	LOCTITE 425	A	AR	1.00
ITM 40	089-08335-0001	SPRING WASHER	A	EA	2.00
ITM 41	089-08341-0000	WASHER FLAT	A	EA	2.00
ITM 42	187-01321-0000	GSKT LTCH PLT HSG		EA	1.00
ITM 43	012-01421-0000	MICROTHIN TAPE		IN	2.00
ITM 44	035-08373-0002	SEALING TAPE TAN	A	IN	0.50
ITM 45	016-01013-0000	VAC GREASE DC 976		AR	1.00
J 13	076-01438-0000	ADAPTER ANTENNA		EA	1.00
L 1	019-02401-0006	COIL 6T	A	EA	1.00
P 3	155-02655-0000	COAXIAL PLUG CBL	A	EA	1.00
REF 1	300-05039-0000	SYS/FRAME ASSY	A	EA	1.00
REF 1	300-05039-0010	MOD SYS FRAME ASSY	A	RF	X.

FCC ID: K95GPH51

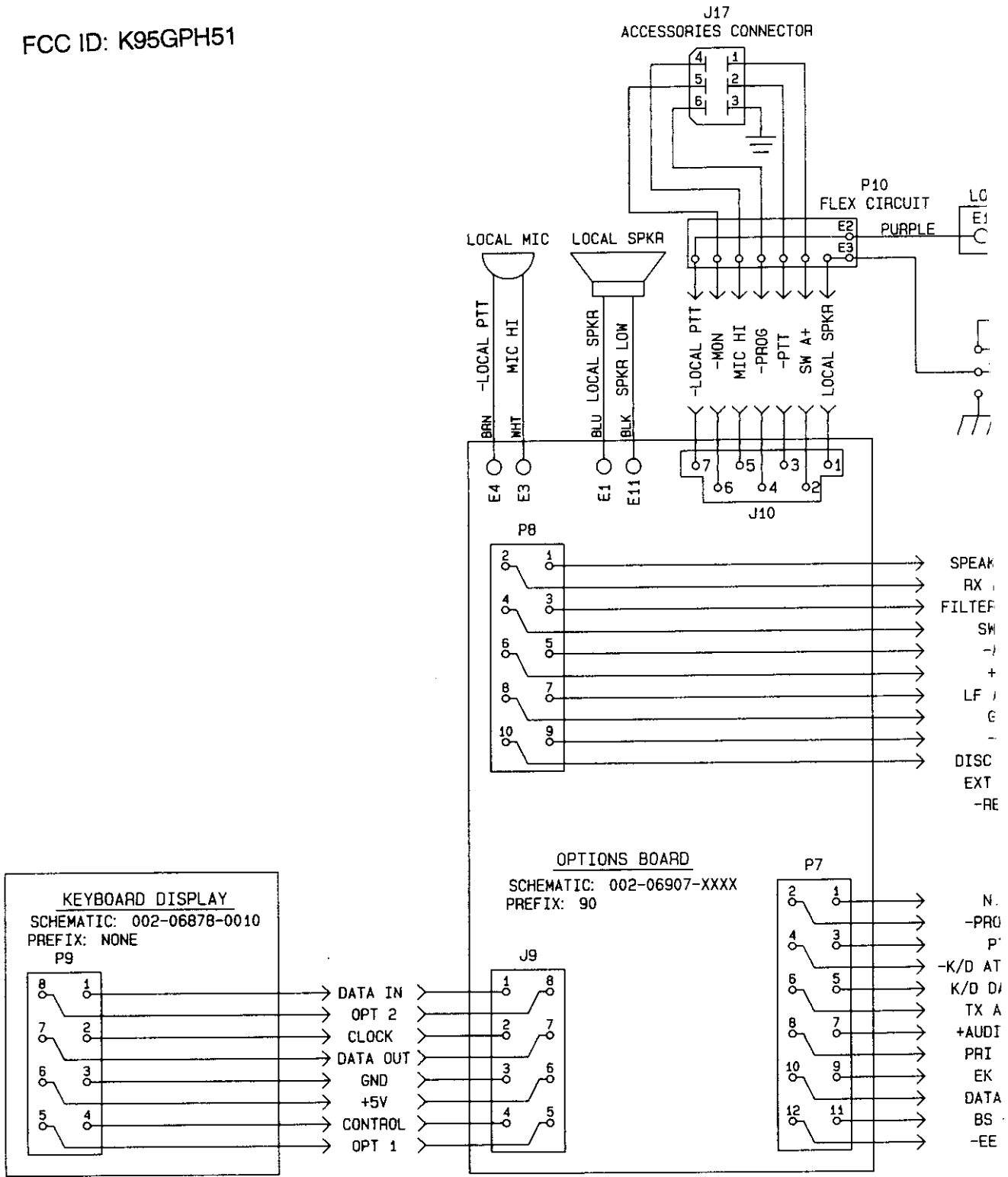

SYSTEMS BOARD

200-08291-00XX

SYMBOL	PART NUMBER	DESCRIPTION	A	UM	QUANTITY					
					0000	0001	0002	0013	0050	0099
C	65	106-05102-0016		EA				1.00		1.00
C	66	106-05102-0016		EA				1.00		1.00
C	67	106-05102-0016		EA				1.00		1.00
CR	1	007-04066-0000		EA				1.00		1.00
CR	2	007-04066-0000		EA				1.00		1.00
CR	3	007-06178-0000		A EA				1.00		1.00
CR	4	007-04133-0000		A EA				1.00		1.00
CR	5	007-04057-0000		EA				1.00		1.00
CR	6	007-06184-0000		EA				1.00		1.00
CR	7	007-06176-0003		EA				1.00		1.00
CR	8	007-06184-0000		EA				1.00		1.00
I	1	122-05007-0004		A EA	1.00	1.00	1.00	1.00		
I	1	122-05010-0000		A EA					1.00	
I	2	120-06056-0003		EA				1.00		1.00
I	3	120-03476-0000		A EA				1.00		1.00
I	4	120-03477-0000		A EA				1.00		1.00
I	5	120-06084-0003		EA				1.00		1.00
I	6	120-06096-0002		A EA				1.00		1.00
I	7	120-02159-0000		A EA		1.00				
I	7	120-02159-0005		A EA	1.00		1.00	1.00	1.00	
I	8	120-03274-0000		A EA				1.00		1.00
I	9	120-03428-0000		A EA				1.00		1.00
I	11	120-00203-0002		A EA				1.00		1.00
I	12	120-06132-0002		EA				1.00		1.00
I	13	120-06131-0000		A EA				1.00		1.00
I	14	120-06131-0000		A EA				1.00		1.00
I	15	120-03460-0000		A EA				1.00		1.00
ITM	1	009-08291-0000		A EA				1.00		1.00
ITM	2	195-00126-0000		EA				1.00		1.00
ITM	3	016-01124-0005		IN				0.50		0.50
ITM	4	026-00030-0000		A IN				2.00		2.00
ITM	5	016-01184-0000		AR				1.00		1.00
ITM	6	016-01124-0003		IN				0.50		0.50
ITM	7	047-09532-0000		A EA				1.00		1.00
ITM	8	013-00175-0000		A EA				1.00		1.00
ITM	9	150-00003-0010		A IN				0.25		0.25
J	7	030-03052-0006		EA				1.00		1.00
J	8	030-03052-0006		EA				1.00		1.00
L	1	019-02660-0017		EA				1.00		1.00
L	2	019-02660-0014		EA				1.00		1.00
L	3	019-02660-0018		EA				1.00		1.00
L	4	019-02660-0019		EA				1.00		1.00
L	5	019-02660-0028		EA				1.00		1.00
L	6	019-02660-0028		EA				1.00		1.00
P	1	030-02219-0021		EA				1.00		1.00
P	2	030-03053-0004		EA				1.00		1.00
Q	1	007-00537-0000		EA				1.00		1.00
Q	2	007-00539-0000		EA				1.00		1.00
Q	3	007-00539-0000		EA				1.00		1.00
Q	4	007-00539-0000		EA				1.00		1.00
Q	5	007-00187-0002		EA				1.00		1.00
Q	6	007-08064-0014		EA				1.00		1.00
Q	7	007-08064-0014		EA				1.00		1.00
Q	8	007-00065-0001		EA				1.00		1.00
Q	9	007-08064-0015		EA				1.00		1.00
Q	10	007-00065-0001		EA				1.00		1.00
Q	11	007-08064-0017		EA				1.00		1.00
Q	12	007-08064-0014		EA				1.00		1.00
Q	13	007-08064-0000		A EA				1.00		1.00
Q	14	007-00065-0001		EA				1.00		1.00
Q	15	007-08064-0005		A EA				1.00		1.00
Q	16	007-08064-0017		EA				1.00		1.00
Q	17	007-08064-0016		EA				1.00		1.00
Q	18	007-08064-0000		A EA				1.00		1.00
Q	19	007-08064-0015		EA				1.00		1.00
Q	20	007-08064-0017		EA				1.00		1.00

CONTROL BOARD

200-06909-0000
 200-06909-0001
 200-06909-0002
 200-06909-0003
 200-06909-0004
 200-06909-0005
 200-06909-0050
 200-06909-0099

EPH 214 1A
 EPH 514 1A, 514 2A, 542 1A, 599 1A, 599 SL, 599 SM, 599 2A
 EPH 502 0A

EPH 214 1A, 514 0A, 514 0M
 EPH 599 1K
 EPH 599 2D, 599 DM
 COMMON BOM

SYMBOL	PART NUMBER	DESCRIPTION	A	UM	QUANTITY							
					0000	0001	0002	0003	0004	0005	0050	0099
	200-06909-0099	COMMON BOM	A	EA	1.00	1.00	1.00	1.00	1.00	1.00		
CJ 1	026-00018-0000	WIRE CKTJMPR 22AWG		EA				1.00				
CR 1	007-06176-0002	DIO MV5374C		EA		1.00		1.00	1.00	1.00		
ITM 1	009-06909-0000	PC BD TOP CONTROL		EA							1.00	1.00
ITM 3	150-00002-0010	TUBING TFLN 26AWG		IN		0.80		0.80	0.80	0.80		
ITM 4	088-02068-0000	SPACER, SWITCH		EA		1.00	1.00	1.00	1.00	1.00	1.00	
ITM 5	026-00030-0000	WIRE CU24AWG TIN	A	IN						0.80		
ITM 6	025-00001-0002	WIRE 26 RED		IN							4.50	
ITM 7	025-00001-0004	WIRE 26 YEL		IN							3.50	
ITM 8	025-00001-0005	WIRE 26 GRN		IN							3.50	
ITM 9	030-01417-0000	CENTER CONTACT	A	EA							3.00	
J 14	030-03121-0003	CONNECTOR HOUSING	A	EA							1.00	
P 11	030-02386-0003	HDR RT ANG 3P		EA							1.00	1.00
P 12	030-02386-0003	HDR RT ANG 3P		EA							1.00	1.00
P 13	030-02386-0003	HDR RT ANG 3P		EA		1.00		1.00	1.00	1.00	1.00	
REF 1	300-06909-0000	TOP CNTRL BD ASSY	A	RF								X.
REF 1	300-06909-0050	CTRL ASSY	A	RF								X.
REF 2	002-06909-0000	SCH CONTROL BD		RF								
REF 2	002-06909-0050	SCH CONT BD DES	A	RF								X.
S 1	031-00474-0010	DIP SW MOD	A	EA		1.00		1.00	1.00		1.00	
S 1	031-00482-0000	DIP SWITCH	A	EA	1.00		1.00					
S 2	031-00480-0000	TOGGLE SWITCH	A	EA		1.00		1.00	1.00	1.00	1.00	
S 3	031-00480-0000	TOGGLE SWITCH	A	EA		1.00			1.00		1.00	
S 4	031-00480-0000	TOGGLE SWITCH	A	EA		1.00	1.00	1.00			1.00	

SYSTEMS BOARD

200-08291-00XX

SYMBOL	PART NUMBER	DESCRIPTION	A	UM	QUANTITY						
					0000	0001	0002	0013	0050	0099	
R	72	130-05202-0013		EA	1.00	1.00	1.00				
R	72	130-05362-0013	A	EA					1.00		
R	73	130-05471-0013		EA				1.00		1.00	
R	74	130-05104-0013		EA				1.00		1.00	
R	75	130-05682-0013		EA				1.00		1.00	
R	76	130-05103-0013		EA				1.00		1.00	
R	77	130-05105-0013		EA				1.00		1.00	
R	78	130-05153-0013		EA				1.00		1.00	
R	79	130-05105-0013		EA				1.00		1.00	
R	80	130-05823-0013		EA				1.00		1.00	
R	81	130-05132-0013		EA				1.00		1.00	
R	82	130-05105-0013		EA				1.00		1.00	
R	83	130-05335-0013		EA				1.00		1.00	
R	84	130-05203-0013		EA				1.00		1.00	
R	85	133-00270-0007	A	EA				1.00		1.00	
R	86	130-05100-0013		EA				1.00		1.00	
R	87	130-05105-0013		EA				1.00		1.00	
R	88	130-05103-0013		EA				1.00		1.00	
R	89	130-05243-0013		EA				1.00		1.00	
R	90	130-05103-0013		EA				1.00		1.00	
R	91	130-05204-0013		EA				1.00		1.00	
R	92	130-05104-0013		EA				1.00		1.00	
R	93	130-05105-0013		EA				1.00		1.00	
R	94	130-05335-0013		EA				1.00		1.00	
R	95	130-05514-0013		EA				1.00		1.00	
R	96	130-05104-0013		EA				1.00		1.00	
R	97	130-05332-0013		EA				1.00		1.00	
R	98	130-05104-0013		EA				1.00		1.00	
R	100	130-05105-0013		EA				1.00		1.00	
R	101	130-05105-0013		EA				1.00		1.00	
R	102	130-05103-0013		EA				1.00		1.00	
R	103	130-05102-0013		EA				1.00		1.00	
R	104	130-05102-0013		EA				1.00		1.00	
R	105	130-05102-0013		EA				1.00		1.00	
R	106	130-05102-0013		EA				1.00		1.00	
R	107	130-05102-0013		EA				1.00		1.00	
R	108	130-05102-0013		EA				1.00		1.00	
REF	1	300-08291-0000	A	RF					X.		X.
REF	2	002-08291-0000	A	RF	X.	X.	X.				
REF	2	002-08291-0013	A	RF				X.			
REF	2	002-08291-0050	A	RF					X.		
RN	1	015-00208-0006	A	EA				1.00		1.00	
RN	2	015-00208-0006	A	EA				1.00		1.00	
RT	1	134-01044-0013		EA				1.00		1.00	
T	1	019-03156-0001	A	EA				1.00		1.00	
Y	1	044-00151-0000		EA				1.00		1.00	
Y	2	044-00301-0000	A	EA				1.00		1.00	

SYSTEMS BOARD

200-08291-0000 2 CHANNEL, 14 CHANNEL
 200-08291-0001 42 CHANNEL
 200-08291-0002 210 CHANNEL
 200-08291-0013 EQH
 200-08291-0050 EPH 599 2D, 599 DM
 200-08291-0099 COMMON BOM

SYMBOL	PART NUMBER	DESCRIPTION	A	UM	QUANTITY					
					0000	0001	0002	0013	0050	0099
	200-08291-0099	COMMON BOM	A	EA	1.00	1.00	1.00		1.00	
B	1	013-00173-0000	A	EA				1.00		1.00
B	2	013-00173-0000	A	EA				1.00		1.00
C	1	096-01186-0062		EA				1.00		1.00
C	2	106-05101-0016		EA				1.00		1.00
C	3	106-05222-0046		EA				1.00		1.00
C	4	106-05222-0046		EA				1.00		1.00
C	5	106-05390-0016		EA				1.00		1.00
C	6	102-00054-0001		EA				1.00		1.00
C	8	106-05221-0048		EA				1.00		1.00
C	9	106-04104-0047		EA				1.00		1.00
C	10	106-04104-0047		EA				1.00		1.00
C	11	106-05221-0048		EA				1.00		1.00
C	12	106-05102-0016		EA				1.00		1.00
C	13	106-00072-0006		EA				1.00		1.00
C	14	106-05102-0047		EA				1.00		1.00
C	15	106-00072-0008		EA				1.00		1.00
C	16	106-00072-0069		EA				1.00		1.00
C	17	106-05102-0016		EA				1.00		1.00
C	18	106-05102-0047		EA				1.00		1.00
C	19	096-01186-0062		EA				1.00		1.00
C	20	106-00120-0000	A	EA				1.00		1.00
C	21	108-05087-0327	A	EA				1.00		1.00
C	22	106-00072-0012	A	EA				1.00		1.00
C	23	106-00072-0044		EA				1.00		1.00
C	24	106-05102-0016		EA				1.00		1.00
C	25	106-05102-0016		EA				1.00		1.00
C	26	106-00072-0046		EA				1.00		1.00
C	27	106-05102-0016		EA				1.00		1.00
C	28	106-05102-0016		EA				1.00		1.00
C	29	106-00072-0034		EA				1.00		1.00
C	30	106-05682-0046		EA				1.00		1.00
C	31	106-00072-0046		EA				1.00		1.00
C	32	106-05221-0048		EA				1.00		1.00
C	33	096-01186-0067		EA				1.00		1.00
C	34	106-05102-0016		EA				1.00		1.00
C	35	106-05221-0048		EA				1.00		1.00
C	36	106-04473-0047		EA				1.00		1.00
C	37	106-05182-0047		EA				1.00		1.00
C	38	097-00213-0045	A	EA				1.00		1.00
C	38	097-00213-0077	A	EA						1.00
C	39	106-04104-0047		EA				1.00		1.00
C	40	106-04104-0047		EA				1.00		1.00
C	41	106-06472-0014		EA				1.00		1.00
C	42	106-06472-0014		EA				1.00		1.00
C	43	096-01186-0062		EA				1.00		1.00
C	44	106-00072-0034		EA				1.00		1.00
C	45	106-00072-0034		EA				1.00		1.00
C	46	096-01186-0062		EA				1.00		1.00
C	47	106-04104-0047		EA				1.00		1.00
C	48	106-05102-0047		EA				1.00		1.00
C	49	096-01186-0064		EA				1.00		1.00
C	50	106-05102-0047		EA				1.00		1.00
C	51	106-05101-0016		EA				1.00		1.00
C	52	106-04222-0016		EA				1.00		1.00
C	53	096-01186-0053	A	EA				1.00		1.00
C	54	106-05102-0047		EA				1.00		1.00
C	55	106-05221-0048		EA				1.00		1.00
C	56	106-05102-0016		EA				1.00		1.00
C	57	106-05102-0016		EA				1.00		1.00
C	58	096-01186-0062		EA				1.00		1.00
C	59	106-05102-0047		EA				1.00		1.00
C	60	106-05102-0016		EA				1.00		1.00
C	61	106-04104-0047		EA				1.00		1.00
C	62	106-05102-0047		EA				1.00		1.00
C	63	106-04104-0047		EA				1.00		1.00



SYSTEMS BOARD

200-08291-00XX

SYMBOL	PART NUMBER	DESCRIPTION	A	UM	QUANTITY						
					0000	0001	0002	0013	0050	0099	
Q	21	007-00815-0000		EA					1.00		1.00
Q	22	007-00535-0001		EA					1.00		1.00
Q	24	007-08064-0017		EA					1.00		1.00
R	1	130-05105-0013		EA					1.00		1.00
R	2	130-05105-0013		EA					1.00		1.00
R	3	133-00271-0018		EA					1.00		1.00
R	4	130-05274-0013		EA					1.00		1.00
R	5	130-05823-0013		EA					1.00		1.00
R	7	130-05244-0013		EA					1.00		1.00
R	8	130-05333-0013		EA					1.00		1.00
R	9	130-05104-0013		EA					1.00		1.00
R	10	130-05333-0013		EA					1.00		1.00
R	11	130-05332-0013		EA					1.00		1.00
R	12	130-05100-0013		EA					1.00		1.00
R	13	130-05472-0013		EA					1.00		1.00
R	14	130-05104-0013		EA					1.00		1.00
R	15	131-05623-0003		A EA					1.00		1.00
R	16	131-05104-0003		A EA					1.00		1.00
R	17	131-05273-0003		A EA					1.00		1.00
R	18	131-05104-0003		A EA					1.00		1.00
R	19	131-05273-0003		A EA					1.00		1.00
R	20	130-05682-0013		EA					1.00		1.00
R	21	130-05102-0013		EA					1.00		1.00
R	22	130-05102-0013		EA					1.00		1.00
R	23	130-05753-0013		A EA					1.00		1.00
R	24	130-05473-0013		EA					1.00		1.00
R	25	130-05335-0013		EA					1.00		1.00
R	26	130-05164-0013		EA					1.00		1.00
R	27	130-05913-0013		EA					1.00		1.00
R	28	130-05163-0013		EA					1.00		1.00
R	29	130-05151-0013		EA					1.00		1.00
R	30	130-05101-0013		EA					1.00		1.00
R	31	130-05103-0013		EA					1.00		1.00
R	32	130-05302-0013		EA					1.00		1.00
R	33	130-05112-0013		EA					1.00		1.00
R	34	130-05200-0013		EA					1.00		1.00
R	35	130-05101-0013		EA					1.00		1.00
R	36	130-05302-0013		EA					1.00		1.00
R	37	130-05513-0013		EA					1.00		1.00
R	38	130-05363-0013		EA					1.00		1.00
R	39	130-05153-0013		EA					1.00		1.00
R	40	133-00271-0010		A EA					1.00		1.00
R	41	130-05183-0013		EA					1.00		1.00
R	42	130-05134-0013		EA					1.00		1.00
R	43	130-05623-0013		EA					1.00		1.00
R	44	130-05333-0013		EA					1.00		1.00
R	45	130-05163-0013		EA					1.00		1.00
R	46	130-05103-0013		EA					1.00		1.00
R	47	130-05103-0013		EA					1.00		1.00
R	48	130-05474-0013		EA					1.00		1.00
R	49	130-05105-0013		EA					1.00		1.00
R	50	130-05243-0013		EA					1.00		1.00
R	51	133-00270-0006		EA					1.00		1.00
R	52	130-05473-0012		A EA					1.00		1.00
R	53	130-05514-0012		EA					1.00		1.00
R	54	130-05105-0012		EA					1.00		1.00
R	55	131-00913-0012		A EA					1.00		1.00
R	56	130-05303-0013		EA					1.00		1.00
R	57	130-05683-0013		EA					1.00		1.00
R	59	130-05104-0013		EA					1.00		1.00
R	60	130-05104-0013		EA					1.00		1.00
R	61	130-05104-0013		EA					1.00		1.00
R	62	130-05333-0012		A EA					1.00		1.00
R	63	130-05513-0012		EA					1.00		1.00
R	64	130-05104-0013		EA					1.00		1.00
R	65	130-05104-0013		EA					1.00		1.00
R	66	130-05104-0013		EA					1.00		1.00
R	67	130-05104-0013		EA					1.00		1.00
R	68	130-05104-0013		EA					1.00		1.00
R	69	130-05104-0013		EA					1.00		1.00
R	70	130-05103-0013		EA					1.00		1.00
R	71	130-05104-0013		EA					1.00		1.00

TOP FRAME ASSEMBLY

200-03475-0002
200-03475-0003

FOR LEXAN CASE
FOR METAL CASE

SYMBOL	PART NUMBER	DESCRIPTION	A	UM	QUANTITY	
					0002	0003
ITM	1	009-06881-0000		EA	1.00	1.00
ITM	2	092-05099-0000		A EA	2.00	2.00
ITM	3	012-01277-0001		EA	1.00	1.00
ITM	4	031-00475-0000		A EA	2.00	2.00
ITM	5	088-01303-0000		EA	1.00	1.00
ITM	6	088-01295-0001		A EA	1.00	1.00
ITM	7	088-01321-0000		EA	1.00	1.00
ITM	8	089-07397-0006		A EA	2.00	2.00
ITM	9	076-01437-0000		EA	1.00	1.00
ITM	11	088-02060-0010		A EA	1.00	1.00
ITM	12	089-06159-0005		EA	1.00	1.00
ITM	13	012-01386-0000		A EA	1.00	1.00
ITM	15	187-01327-0000		A EA	1.00	1.00
ITM	16	187-01328-0000		EA	1.00	
ITM	17	088-01313-0000		EA		1.00
ITM	17	088-02076-0001		A EA	1.00	
ITM	18	047-07474-0001		A EA	1.00	1.00
ITM	19	150-00003-0010		A IN	0.50	1.50
ITM	20	026-00030-0000		A IN	1.00	0.50
ITM	21	025-00001-0007		IN	1.20	1.20
ITM	22	025-00001-0005		IN	2.25	2.25
ITM	23	016-01013-0000		AR		1.00
ITM	24	089-07437-0001		A EA		1.00
ITM	25	187-01745-0000		A EA		1.00
J	14	033-00128-0000		A EA	1.00	1.00
J	15	033-00127-0000		A EA	1.00	1.00
J	17	030-02529-0000		EA	1.00	1.00
P	10	009-06911-0000		EA	1.00	1.00
REF	1	300-03475-0001		A RF	X	X

2 WATT RX/TX BOARD

200-08473-00XX

SYMBOL	PART NUMBER	DESCRIPTION	A	UM	QUANTITY	
					0000	0050
C	78	106-05103-0046		EA	1.00	1.00
C	79	096-01186-0062		EA	1.00	1.00
C	80	106-04104-0047		EA	1.00	1.00
C	81	106-05102-0047		EA	1.00	1.00
C	87	096-01186-0062		EA	1.00	1.00
C	88	106-00072-0004		EA	1.00	1.00
C	101	106-00072-0026		EA		1.00
C	102	106-00072-0050		EA		1.00
C	103	106-00072-0044		EA		1.00
C	104	106-00072-0002		EA		1.00
C	105	106-00072-0026		EA		1.00
C	106	106-00072-0032		EA		1.00
CR	1	007-06418-0000		A EA	1.00	1.00
CR	2	007-04134-0000		A EA	1.00	1.00
CR	6	007-06188-0000		A EA	1.00	1.00
CR	7	007-06188-0000		A EA	1.00	1.00
CR	8	007-06188-0000		A EA	1.00	1.00
CR	9	007-06188-0000		A EA	1.00	1.00
CR	13	007-06418-0000		A EA	1.00	1.00
CR	14	007-06226-0001		A EA	1.00	
FL	1	017-00096-0000		EA	1.00	
FL	1	017-00139-0000		A EA		1.00
FL	2	017-00106-0000		EA	1.00	
FL	2	017-00140-0000		A EA		1.00
FL	3	017-00137-0000		A EA	1.00	1.00
I	2	120-03193-0000		A EA	1.00	1.00
I	3	120-03473-0000		A EA	1.00	1.00
ITM	1	009-08473-0000		A EA	1.00	1.00
ITM	2	016-01004-0000		AR	1.00	1.00
ITM	3	090-00388-0000		EA	1.00	1.00
ITM	4	091-00320-0000		EA	1.00	1.00
ITM	8	016-01124-0002		IN	0.35	0.35
ITM	9	016-01124-0002		IN	0.35	0.35
ITM	10	016-01124-0002		IN	0.50	0.50
ITM	11	047-06735-0001		EA	2.00	2.00
ITM	50	047-09979-0000		A EA		1.00
J	1	030-01386-0001		EA	3.00	3.00
J	2	030-01386-0001		EA	8.00	8.00
J	3	030-00417-0000		EA	1.00	1.00
L	1	019-02660-0048		A EA	1.00	1.00
L	2	019-02701-0001		A EA	1.00	1.00
L	3	019-02701-0002		A EA	1.00	1.00
L	4	019-02701-0002		A EA	1.00	1.00
L	5	019-02701-0000		A EA	1.00	1.00
L	7	019-02660-0048		A EA	1.00	1.00
L	8	019-02660-0044		A EA	1.00	1.00
L	10	019-02660-0046		A EA	1.00	1.00
L	12	019-02660-0050		A EA	1.00	1.00
L	13	019-02660-0046		A EA		1.00
L	14	019-02660-0046		A EA	1.00	1.00
L	15	019-02660-0003		EA	1.00	1.00
L	16	019-02660-0047		A EA	1.00	1.00
L	18	019-02660-0012		EA	1.00	1.00
L	19	019-02660-0042		A EA	1.00	1.00
L	21	019-02660-0030		EA	1.00	1.00
L	24	019-02714-0000		A EA	1.00	1.00
L	25	019-02717-7205		A EA	1.00	1.00
L	26	019-02717-8205		A EA	1.00	1.00
L	101	019-02660-0033		EA		1.00
L	102	019-02660-0039		EA		1.00
Q	1	007-00943-0000		A EA	1.00	1.00
Q	2	007-08064-0017		EA	1.00	1.00
Q	3	007-08064-0015		EA	1.00	1.00
Q	4	007-00529-0000		EA	1.00	1.00
Q	6	007-00187-0002		EA	1.00	1.00
Q	7	007-00907-0000		EA	1.00	1.00

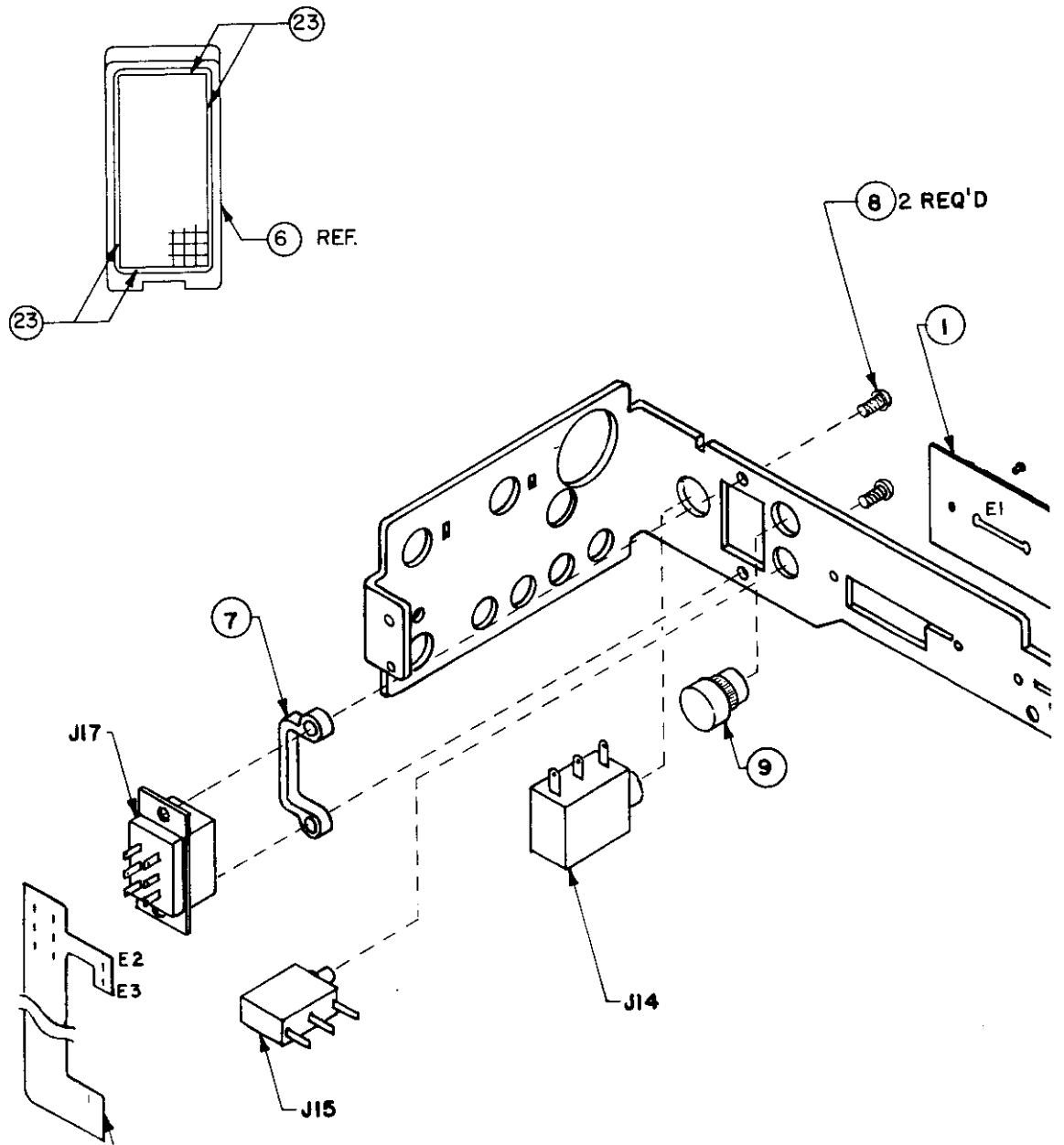

WIRING DIAGRAM

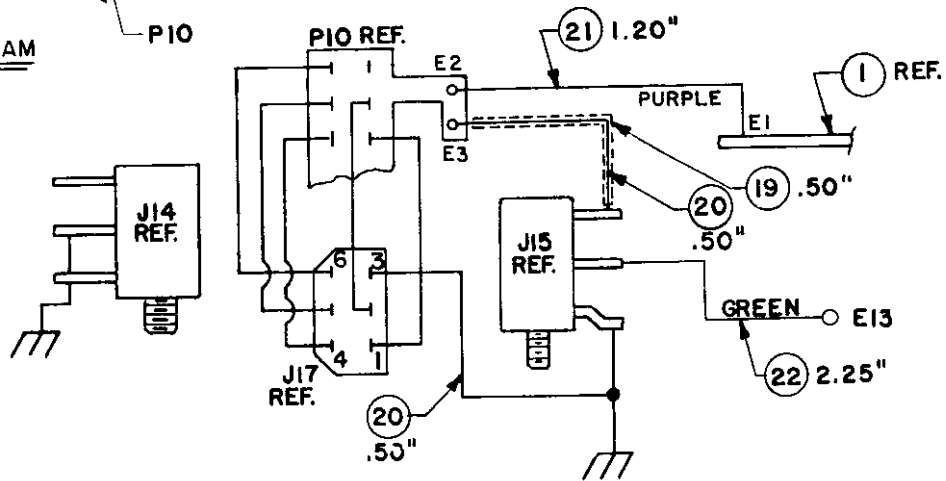

5 WATT RX/TX BOARD

200-08293-00XX

SYMBOL	PART NUMBER	DESCRIPTION	A	UM	QUANTITY		
					0000	0013	0050
C	71	106-00072-0024		EA	1.00	1.00	1.00
C	72	106-00072-0054		EA	1.00	1.00	1.00
C	73	106-00072-0014		EA	1.00	1.00	1.00
C	74	106-00072-0034		EA	1.00	1.00	1.00
C	75	106-05561-0046		EA	1.00	1.00	1.00
C	76	106-05102-0047		EA	1.00	1.00	1.00
C	77	096-01186-0064		EA	1.00	1.00	1.00
C	78	106-05103-0046		EA	1.00	1.00	1.00
C	79	096-01186-0062		EA	1.00	1.00	
C	79	106-05272-0047		EA			1.00
C	80	106-04104-0047		EA	1.00	1.00	1.00
C	81	106-05102-0047		EA	1.00	1.00	1.00
C	87	096-01186-0062		EA	1.00	1.00	1.00
C	88	106-00072-0004		EA	1.00	1.00	1.00
C	101	106-00072-0026		EA			1.00
C	102	106-00072-0050		EA			1.00
C	103	106-00072-0044		EA			1.00
C	104	106-00072-0002		EA			1.00
C	105	106-00072-0026		EA			1.00
C	106	106-00072-0032		EA			1.00
CR	1	007-06418-0000		A EA	1.00	1.00	1.00
CR	2	007-04134-0000		A EA	1.00	1.00	1.00
CR	6	007-06188-0000		A EA	1.00	1.00	1.00
CR	7	007-06188-0000		A EA	1.00	1.00	1.00
CR	8	007-06188-0000		A EA	1.00	1.00	1.00
CR	9	007-06188-0000		A EA	1.00	1.00	1.00
CR	13	007-06418-0000		A EA	1.00	1.00	1.00
CR	14	007-06226-0001		A EA	1.00	1.00	
FL	1	017-00096-0000		EA	1.00	1.00	
FL	1	017-00129-0000		A EA			1.00
FL	2	017-00106-0000		EA	1.00	1.00	
FL	2	017-00140-0000		A EA			1.00
FL	3	017-00137-0000		A EA	1.00	1.00	1.00
I	2	120-03193-0000		A EA	1.00	1.00	1.00
I	3	120-03473-0000		A EA	1.00	1.00	1.00
ITM	1	009-08293-0000		A EA	1.00	1.00	1.00
ITM	4	091-00320-0000		EA	1.00	1.00	1.00
ITM	5	076-01455-0000		A EA	1.00	1.00	1.00
ITM	8	016-01124-0002		IN	0.35	0.35	0.35
ITM	9	016-01124-0002		IN	0.35	0.35	0.35
ITM	10	016-01124-0002		IN	0.50	0.50	0.50
ITM	11	047-06735-0001		EA	2.00	2.00	2.00
ITM	12	047-06707-0001		A EA	1.00	1.00	1.00
J	1	030-01386-0001		EA	3.00	3.00	3.00
J	2	030-01386-0001		EA	8.00	8.00	8.00
J	3	030-00417-0000		EA	1.00	1.00	1.00
L	1	019-02660-0048		A EA	1.00	1.00	1.00
L	2	019-02701-0001		A EA	1.00	1.00	1.00
L	3	019-02701-0002		A EA	1.00	1.00	1.00
L	4	019-02701-0002		A EA	1.00	1.00	1.00
L	5	019-02701-0000		A EA	1.00	1.00	1.00
L	7	019-02660-0050		A EA	1.00	1.00	1.00
L	8	019-02660-0045		A EA	1.00	1.00	1.00
L	10	019-02660-0047		A EA	1.00	1.00	1.00
L	11	019-02660-0003		EA	1.00	1.00	1.00
L	12	019-02660-0044		A EA	1.00	1.00	1.00
L	14	019-02660-0003		EA	1.00	1.00	1.00
L	16	019-02660-0044		A EA	1.00	1.00	1.00
L	17	019-02660-0013		EA	1.00	1.00	1.00
L	18	019-02404-0003		A EA	1.00	1.00	1.00
L	21	019-02660-0030		EA	1.00	1.00	1.00
L	22	019-02404-0005		A EA	1.00	1.00	1.00
L	23	019-02404-0003		A EA	1.00	1.00	1.00
L	24	019-02401-0024		A EA	1.00	1.00	1.00
L	25	019-02401-0010		A EA	1.00	1.00	1.00
L	26	019-02401-0025		A EA	1.00	1.00	1.00
L	101	019-02660-0033		EA			1.00

RX/TX FRAME ASSEMBLY

200-05042-0000 5 WATT
 200-05042-0001 2 WATT
 200-05042-0050 5 WATT DES

SYMBOL	PART NUMBER	DESCRIPTION	A	UM	QUANTITY		
					0000	0001	0050
ASY 1	200-08293-0000	EPH R/T	A	EA	1.00		
ASY 1	200-08293-0050	EPH R/T DES	A	EA			1.00
ASY 1	200-08473-0000	VHF P1 RX/TS BD 2W	A	EA		1.00	
ITM 1	047-09528-0001	SUB-FRAME T1 RT	A	EA	1.00	1.00	1.00
ITM 2	089-06004-0003	SCR FHP 2-56X3/16		EA	3.00		3.00
ITM 3	073-00614-0001	CSTG HEAT SINK W/F	A	EA	1.00		1.00
ITM 4	016-01004-0000	COMPOUND THRML JNT		AR	1.00		1.00
ITM 5	012-01005-0003	TAPE MYLAR .250 W	A	IN	0.80		0.80
REF 1	300-05042-0000	RT FRAME	A	RF	X.	X.	X.

FRONT COVER ASSEMBLY

200-03477-0022 EPH 599 SM
 200-03477-0023 EPH 599 2D
 200-03477-0024 EPH 599 DM
 200-03477-0099 COMMON BOM

SYMBOL	PART NUMBER	DESCRIPTION	A	UM	QUANTITY			
					0022	0023	0024	0099
	200-03477-0099	COMMON BOM	A	EA	1.00	1.00	1.00	
ASY 1	071-00082-0000	DES OPTION BD	A	EA		1.00	1.00	
ASY 1	200-08248-0000	UCOM BD	A	EA	1.00			
ASY 2	200-03223-0005	KBD/DSPL ASSY MOD	A	EA		1.00	1.00	
ASY 2	200-03223-0022	ALPHA DSPL ASSY	A	EA	1.00			
ITM 3	187-01696-0000	KYBD DSPLY GASKET		EA				1.00
ITM 4	088-02080-0002	GOLD INLY NAMEPLT		EA	1.00	1.00	1.00	
ITM 5	073-00893-0001	COVER W/FINISH	A	EA	1.00		1.00	
ITM 5	088-02095-0002	FRONT COVER EPH		EA		1.00		
ITM 7	088-01322-0000	BUSHING MICROPHONE		EA				1.00
ITM 8	047-06715-0000	SPEAKER CLIP		EA				2.00
ITM 9	089-06292-0002	SCR PHP 2-56X1/78		EA				2.00
ITM 12	076-01463-0000	STANDOFF SPKR MT		EA				1.00
ITM 13	076-01440-0002	STANDOFF 1.105		EA				2.00
ITM 14	089-06292-0006	SCR PHP 2-56X3/8		EA				1.00
ITM 15	089-07075-0000	SCR PHP 2-28	A	EA	4.00	4.00	4.00	
ITM 16	090-00459-0001	NUT FLAT M2.5	A	EA				2.00
ITM 17	088-01306-0000	DOOR KEYBOARD BLK	A	EA	1.00	1.00	1.00	
ITM 20	025-00001-0000	WIRE 26 BLK		IN				2.25
ITM 21	025-00001-0006	WIRE 26 BLU		IN				3.00
ITM 22	150-00042-0010	SHRINK TUBING 187	A	IN				0.90
ITM 23	016-01112-0000	HOT MELT 1943		AR				1.00
ITM 24	187-01319-0000	GRILL CLOTH, SPEAK		EA				1.00
ITM 25	016-01011-0000	ADH PLIOBOND 20		AR				1.00
LS 1	038-00034-0000	SPEAKER 8OHMS 1/2W	A	EA				1.00
MK 1	038-00026-0020	MIC CRTRDG MOD	A	EA				1.00
REF 1	300-03477-0000	FRONT COVER ASSY	A	RF				X

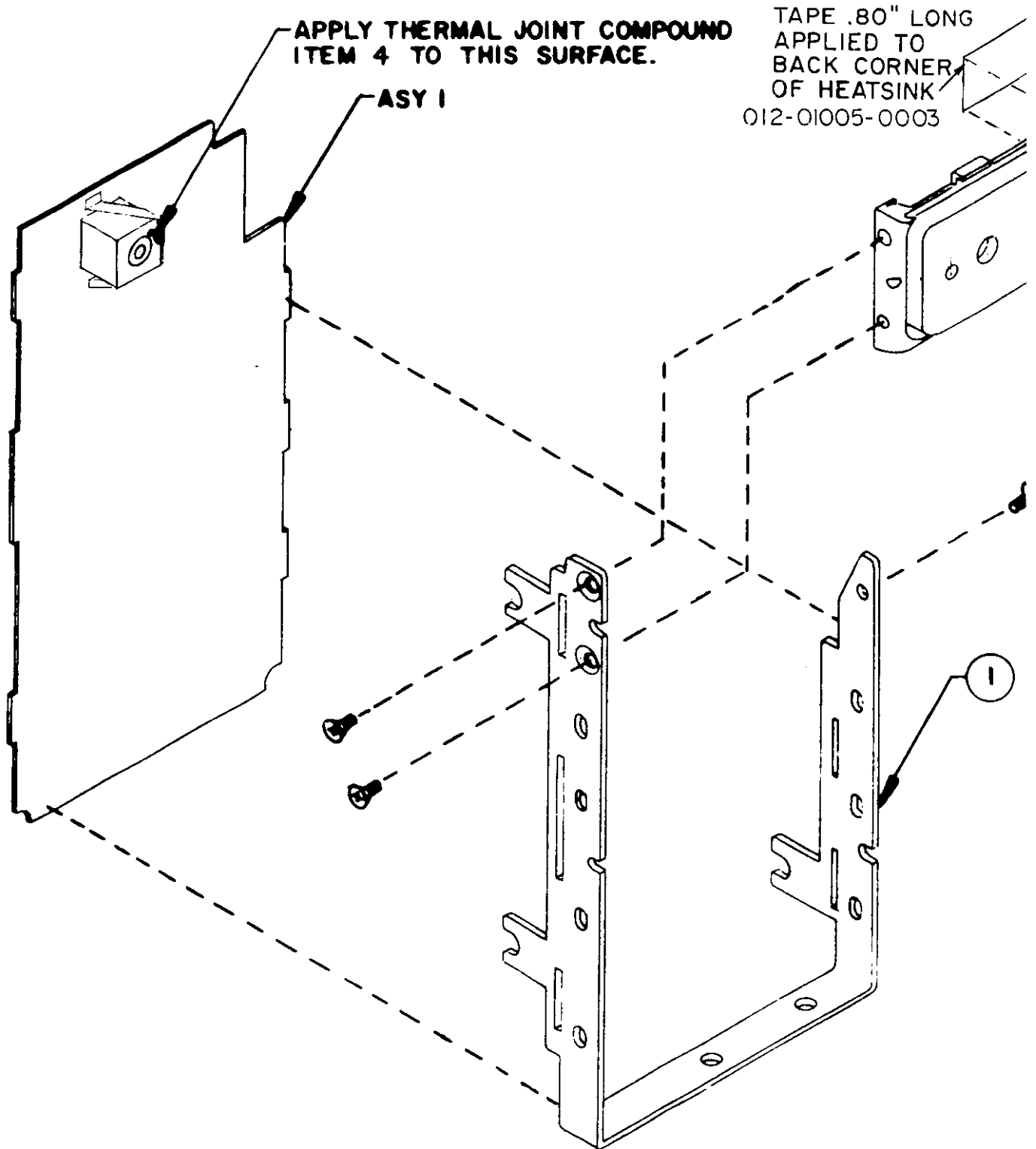

OPTIONS BOARD

200-06907-0020

SYMBOL	PART NUMBER	DESCRIPTION	A	UM	QUANTITY
--------	-------------	-------------	---	----	----------

0020

Q	1	007-08064-0000	XSTR PNP 10K, 10K	A	EA	1.00
Q	2	007-08064-0016	XSTR PNP 47K, 47K		EA	1.00
R	1	130-05163-0023	RES CHIP 16KEW5%		EA	1.00
R	2	130-05823-0023	RES CHIP 82KEW5%		EA	1.00
R	3	130-05164-0023	RES CHIP 160K EW5%		EA	1.00
R	4	130-05334-0023	RES CHIP 330KEW5%		EA	1.00
R	5	130-05514-0022	RES CH 510K EW 2%		EA	1.00
R	6	130-05274-0022	RES CHIP 270KEW2%		EA	1.00
R	7	130-05824-0022	RES CH 820K EW 2%		EA	1.00
R	8	130-05623-0022	RES CHIP 62KEW2%		EA	1.00
R	9	130-05474-0022	RES CH 470K EW 2%		EA	1.00
R	10	130-05272-0022	RES CH 2.7K 2%		EA	1.00
R	11	130-05204-0023	RES CHIP 200KEW5%		EA	1.00
R	12	130-05204-0023	RES CHIP 200KEW5%		EA	1.00
R	14	130-05224-0023	RES CHIP 220K5%EW		EA	1.00
R	15	130-05224-0023	RES CHIP 220K5%EW		EA	1.00
R	16	130-05154-0023	RES CHIP 150K5%EW		EA	1.00
R	17	130-05510-0023	RES CHIP 51 EW 5%		EA	1.00
R	18	130-05392-0023	RES CHIP 3.9KEW5%		EA	1.00
R	19	130-05432-0023	RES CHIP 4.3KEW5%		EA	1.00
R	20	130-05563-0023	RES CHIP 56K5%EW		EA	1.00
R	21	130-05102-0023	RES CH 1K EW 5%		EA	1.00
R	22	130-05304-0023	RES CHIP 300KEW5%		EA	1.00
R	23	130-05102-0023	RES CH 1K EW 5%		EA	1.00
R	24	130-05304-0023	RES CHIP 300KEW5%		EA	1.00
R	25	130-05204-0023	RES CHIP 200KEW5%		EA	1.00
R	26	130-05102-0023	RES CH 1K EW 5%		EA	1.00
R	27	130-05124-0023	RES CHIP 120KEW5%		EA	1.00
R	28	130-05563-0023	RES CHIP 56K5%EW		EA	1.00
R	29	130-05393-0023	RES CHIP 39K EW 5%		EA	1.00
R	30	130-05103-0023	RES CH 10K EW 5%		EA	1.00
R	33	130-05244-0023	RES CHIP 240K5%EW		EA	1.00
R	34	130-05244-0023	RES CHIP 240K5%EW		EA	1.00
R	39	130-05134-0023	RES CHIP 130KEW5%		EA	1.00
R	40	130-05102-0023	RES CH 1K EW 5%		EA	1.00
R	41	130-05102-0023	RES CH 1K EW 5%		EA	1.00
R	42	130-05104-0023	RES CH 100K EW 5%		EA	1.00
R	43	130-05102-0023	RES CH 1K EW 5%		EA	1.00
R	44	130-05102-0023	RES CH 1K EW 5%		EA	1.00
R	45	130-05823-0022	RES CHIP 82KEW2%		EA	1.00
R	46	130-05104-0022	RES CHIP 100KEW2%		EA	1.00
R	47	130-05913-0022	RES CHIP 91KEW2%		EA	1.00
R	48	130-05105-0023	RES CHIP 1M EW 5%		EA	1.00
R	49	130-05103-0023	RES CH 10K EW 5%		EA	1.00
R	52	130-05100-0023	RES CH 10 EW 5%		EA	1.00
R	53	130-05100-0023	RES CH 10 EW 5%		EA	1.00
R	54	130-05100-0023	RES CH 10 EW 5%		EA	1.00
R	55	130-05100-0023	RES CH 10 EW 5%		EA	1.00
R	56	130-05100-0023	RES CH 10 EW 5%		EA	1.00
R	57	130-05273-0023	RES CHIP 27K EW 5%		EA	1.00
R	58	130-05134-0023	RES CHIP 130KEW5%		EA	1.00
REF	1	300-06907-0020	OPTIONS BD PC ASSY	A	RF	X.
REF	2	002-06907-0020	SCH OPTIONS BD	A	RF	X.

2 WATT RX/TX BOARD

200-08473-0000
200-08473-0050

DES

SYMBOL	PART NUMBER	DESCRIPTION	A	UM	QUANTITY		
					0000	0050	
B	2	013-00173-0000	FERRITE BEAD	A	EA	1.00	1.00
B	3	013-00173-0000	FERRITE BEAD	A	EA	1.00	1.00
B	4	013-00172-0000	FERR BEAD SRFC MT	A	EA	1.00	1.00
B	5	013-00173-0000	FERRITE BEAD	A	EA	1.00	1.00
B	6	013-00172-0000	FERR BEAD SRFC MT	A	EA	1.00	1.00
B	7	013-00173-0000	FERRITE BEAD	A	EA	1.00	1.00
C	1	106-00072-0034	CAP CH 56PFNPO/50V		EA	1.00	1.00
C	2	106-00072-0058	CAP CR CH 5.1PF		EA	1.00	1.00
C	3	106-00072-0053	CAP CR CH 3.0PF		EA	1.00	1.00
C	4	106-05561-0046	CH 560PF 7R/50V		EA	1.00	1.00
C	5	106-00072-0028	CAP CH 36PFNPO/50V		EA	1.00	1.00
C	6	106-00116-0049	CAP CHIP PORCELAIN	A	EA	1.00	1.00
C	7	106-00116-0049	CAP CHIP PORCELAIN	A	EA	1.00	1.00
C	8	106-05102-0047	CAP CH 1K X7R/50V		EA	1.00	1.00
C	9	106-05102-0016	CAP CH 1K NPO/50V		EA	1.00	1.00
C	10	106-05102-0047	CAP CH 1K X7R/50V		EA	1.00	1.00
C	11	106-00116-0049	CAP CHIP PORCELAIN	A	EA	1.00	1.00
C	12	106-00116-0049	CAP CHIP PORCELAIN	A	EA	1.00	1.00
C	13	106-04104-0047	CH 100KX7R/50V		EA	1.00	1.00
C	14	106-05561-0046	CH 560PF 7R/50V		EA	1.00	1.00
C	15	106-05561-0046	CH 560PF 7R/50V		EA	1.00	1.00
C	16	106-05103-0046	CAP CH 10K X7R/50V		EA	1.00	1.00
C	17	106-05102-0016	CAP CH 1K NPO/50V		EA	1.00	1.00
C	18	106-05102-0047	CAP CH 1K X7R/50V		EA	1.00	1.00
C	19	106-05102-0047	CAP CH 1K X7R/50V		EA	1.00	1.00
C	20	106-00072-0012	CAP CH12PF NPO/50V	A	EA	1.00	1.00
C	21	106-00072-0032	CAP CH 47PFNPO/50V		EA	1.00	1.00
C	22	106-00072-0010	CAP CH8.2PFNPO/50V		EA	1.00	1.00
C	23	106-00072-0010	CAP CH8.2PFNPO/50V		EA	1.00	1.00
C	24	106-05102-0047	CAP CH 1K X7R/50V		EA	1.00	1.00
C	28	106-05103-0046	CAP CH 10K X7R/50V		EA	1.00	1.00
C	29	106-05103-0046	CAP CH 10K X7R/50V		EA	1.00	1.00
C	30	106-05121-0016	CAP CH120PFNPO/50V		EA	1.00	1.00
C	31	106-00072-0042	CAP CH 33PFNPO/50V		EA	1.00	1.00
C	33	106-04473-0048	CAP CH 47K X7R/50V		EA	1.00	1.00
C	34	106-04473-0048	CAP CH 47K X7R/50V		EA	1.00	1.00
C	35	106-05121-0016	CAP CH120PFNPO/50V		EA	1.00	1.00
C	38	106-05221-0048	CAP CH 220X7R/50V		EA	1.00	1.00
C	38	106-05561-0046	CH 560PF 7R/50V		EA	1.00	1.00
C	39	106-05121-0016	CAP CH120PFNPO/50V		EA	1.00	1.00
C	39	106-05560-0016	CAP CH 56PFNPO/50V		EA	1.00	1.00
C	40	106-05560-0016	CAP CH 56PFNPO/50V		EA	1.00	1.00
C	41	106-05122-0047	CAPCH1200PFX7R/50V		EA	1.00	1.00
C	41	106-05332-0047	CAPCH3.3KX7R/50V10		EA	1.00	1.00
C	42	106-05222-0046	CAP CH 2.2KX7R/50V		EA	1.00	1.00
C	45	106-04104-0047	CH 100KX7R/50V		EA	1.00	1.00
C	46	106-00072-0016	CAP CH 15PFNPO/50V		EA	1.00	1.00
C	47	106-05102-0047	CAP CH 1K X7R/50V		EA	1.00	1.00
C	48	106-05102-0047	CAP CH 1K X7R/50V		EA	1.00	1.00
C	50	096-01186-0062	CAP 1.0UF 16V 20%		EA	1.00	1.00
C	51	106-05102-0047	CAP CH 1K X7R/50V		EA	1.00	1.00
C	52	106-00072-0024	CAP CH 22PFNPO/50V		EA	1.00	1.00
C	53	106-05102-0047	CAP CH 1K X7R/50V		EA	1.00	1.00
C	54	106-05102-0047	CAP CH 1K X7R/50V		EA	1.00	1.00
C	56	106-05102-0047	CAP CH 1K X7R/50V		EA	1.00	1.00
C	57	106-00072-0042	CAP CH 33PFNPO/50V		EA	1.00	1.00
C	59	106-00072-0034	CAP CH 56PFNPO/50V		EA	1.00	1.00
C	60	106-05102-0047	CAP CH 1K X7R/50V		EA	1.00	1.00
C	62	106-05103-0046	CAP CH 10K X7R/50V		EA	1.00	1.00
C	63	106-05102-0047	CAP CH 1K X7R/50V		EA	1.00	1.00
C	67	106-00072-0042	CAP CH 33PFNPO/50V		EA	1.00	1.00
C	68	106-00072-0061	CAP CR CH 9.1PF		EA	1.00	1.00
C	69	106-00072-0032	CAP CH 47PFNPO/50V		EA	1.00	1.00
C	70	106-00072-0044	CAP CH 1.5PF		EA	1.00	1.00
C	71	106-00072-0034	CAP CH 56PFNPO/50V		EA	1.00	1.00
C	72	106-00072-0010	CAP CH8.2PFNPO/50V		EA	1.00	1.00
C	73	106-00072-0020	CAP CH 20PFNPO/50V		EA	1.00	1.00
C	74	106-00072-0034	CAP CH 56PFNPO/50V		EA	1.00	1.00
C	75	106-05561-0046	CH 560PF 7R/50V		EA	1.00	1.00
C	76	106-05102-0047	CAP CH 1K X7R/50V		EA	1.00	1.00
C	77	096-01186-0064	CAP 10UF 16V 20%		EA	1.00	1.00



5 WATT RX/TX BOARD

200-08293-0000
 200-08293-0013
 200-08293-0050

EQH
 DES

SYMBOL	PART NUMBER	DESCRIPTION	A	UM	QUANTITY			
					0000	0013	0050	
B	2	013-00173-0000	FERRITE BEAD	A	EA	1.00	1.00	1.00
B	3	013-00173-0000	FERRITE BEAD	A	EA	1.00	1.00	1.00
B	4	013-00172-0000	FERR BEAD SRFC MT	A	EA	1.00	1.00	1.00
B	5	013-00173-0000	FERRITE BEAD	A	EA	1.00	1.00	1.00
B	7	013-00173-0000	FERRITE BEAD	A	EA	1.00	1.00	1.00
C	1	106-00072-0034	CAP CH 56PFNPO/50V		EA	1.00	1.00	1.00
C	2	106-00072-0058	CAP CR CH 5.1PF		EA	1.00	1.00	1.00
C	3	106-00072-0053	CAP CR CH 3.0PF		EA	1.00	1.00	1.00
C	4	106-05561-0046	CH 560PF 7R/50V		EA	1.00	1.00	1.00
C	5	106-00072-0028	CAP CH 36PFNPO/50V		A	EA	1.00	1.00
C	6	106-00116-0049	CAP CHIP PORCELAIN		A	EA	1.00	1.00
C	7	106-00116-0049	CAP CHIP PORCELAIN		A	EA	1.00	1.00
C	8	106-05102-0047	CAP CH 1K X7R/50V		EA	1.00	1.00	1.00
C	9	106-05102-0016	CAP CH 1K NPO/50V		EA	1.00	1.00	1.00
C	10	106-05102-0047	CAP CH 1K X7R/50V		EA	1.00	1.00	1.00
C	11	106-00116-0049	CAP CHIP PORCELAIN		A	EA	1.00	1.00
C	12	106-00116-0049	CAP CHIP PORCELAIN		A	EA	1.00	1.00
C	13	106-04104-0047	CH 100KX7R/50V		EA	1.00	1.00	1.00
C	14	106-05561-0046	CH 560PF 7R/50V		EA	1.00	1.00	1.00
C	15	106-05561-0046	CH 560PF 7R/50V		EA	1.00	1.00	1.00
C	16	106-05103-0046	CAP CH 10K X7R/50V		EA	1.00	1.00	1.00
C	17	106-05102-0016	CAP CH 1K NPO/50V		EA	1.00	1.00	1.00
C	18	106-05102-0047	CAP CH 1K X7R/50V		EA	1.00	1.00	1.00
C	19	106-05102-0047	CAP CH 1K X7R/50V		EA	1.00	1.00	1.00
C	20	106-00072-0012	CAP CH12PF NPO/50V		A	EA	1.00	1.00
C	21	106-00072-0032	CAP CH 47PFNPO/50V		EA	1.00	1.00	1.00
C	22	106-00072-0010	CAP CH8 2PFNPO/50V		EA	1.00	1.00	1.00
C	23	106-00072-0010	CAP CH8 2PFNPO/50V		EA	1.00	1.00	1.00
C	24	106-05102-0047	CAP CH 1K X7R/50V		EA	1.00	1.00	1.00
C	28	106-05103-0046	CAP CH 10K X7R/50V		EA	1.00	1.00	1.00
C	29	106-05103-0046	CAP CH 10K X7R/50V		EA	1.00	1.00	1.00
C	30	106-05121-0016	CAP CH120PFNPO/50V		EA	1.00	1.00	1.00
C	31	106-00072-0042	CAP CH 33PFNPO/50V		EA	1.00	1.00	1.00
C	33	106-04473-0048	CAP CH 47K X7R/50V		EA	1.00	1.00	1.00
C	34	106-04473-0048	CAP CH 47K X7R/50V		EA	1.00	1.00	1.00
C	35	106-05121-0016	CAP CH120PFNPO/50V		EA	1.00	1.00	1.00
C	38	106-05221-0048	CAP CH 220X7R/50V		EA	1.00	1.00	1.00
C	38	106-05561-0046	CH 560PF 7R/50V		EA	1.00	1.00	1.00
C	39	106-05121-0016	CAP CH120PFNPO/50V		EA	1.00	1.00	1.00
C	39	106-05560-0016	CAP CH 56PFNPO/50V		EA	1.00	1.00	1.00
C	40	106-05560-0016	CAP CH 56PFNPO/50V		EA	1.00	1.00	1.00
C	41	106-05122-0047	CAPCH1200PFX7R/50V		EA	1.00	1.00	1.00
C	41	106-05332-0047	CAPCH3 3KX7R/50V10		EA	1.00	1.00	1.00
C	42	106-05222-0046	CAP CH 2.2KX7R/50V		EA	1.00	1.00	1.00
C	45	106-04104-0047	CH 100KX7R/50V		EA	1.00	1.00	1.00
C	46	106-00072-0018	CAP CH 18PFNPO/50V		EA	1.00	1.00	1.00
C	47	106-05102-0047	CAP CH 1K X7R/50V		EA	1.00	1.00	1.00
C	48	106-05102-0047	CAP CH 1K X7R/50V		EA	1.00	1.00	1.00
C	49	106-00072-0026	CAP CH 27PFNPO/50V		EA	1.00	1.00	1.00
C	50	096-01186-0062	CAP 1.0UF 16V 20%		EA	1.00	1.00	1.00
C	51	106-05102-0047	CAP CH 1K X7R/50V		EA	1.00	1.00	1.00
C	52	106-00072-0032	CAP CH 47PFNPO/50V		EA	1.00	1.00	1.00
C	53	106-00072-0036	CAP CH 68PFNPO/50V		EA	1.00	1.00	1.00
C	54	106-05102-0047	CAP CH 1K X7R/50V		EA	1.00	1.00	1.00
C	55	106-04104-0047	CH 100KX7R/50V		EA	1.00	1.00	1.00
C	56	106-05102-0047	CAP CH 1K X7R/50V		EA	1.00	1.00	1.00
C	57	106-00072-0032	CAP CH 47PFNPO/50V		EA	1.00	1.00	1.00
C	58	106-00072-0036	CAP CH 68PFNPO/50V		EA	1.00	1.00	1.00
C	59	106-00072-0036	CAP CH 68PFNPO/50V		EA	1.00	1.00	1.00
C	60	106-05102-0047	CAP CH 1K X7R/50V		EA	1.00	1.00	1.00
C	61	106-04104-0047	CH 100KX7R/50V		EA	1.00	1.00	1.00
C	62	106-00072-0032	CAP CH 47PFNPO/50V		EA	1.00	1.00	1.00
C	63	106-00072-0024	CAP CH 22PFNPO/50V		EA	1.00	1.00	1.00
C	64	106-00072-0032	CAP CH 47PFNPO/50V		EA	1.00	1.00	1.00
C	65	106-00072-0032	CAP CH 47PFNPO/50V		EA	1.00	1.00	1.00
C	66	106-00072-0024	CAP CH 22PFNPO/50V		EA	1.00	1.00	1.00
C	67	106-00072-0016	CAP CH 15PFNPO/50V		EA	1.00	1.00	1.00
C	68	106-00072-0058	CAP CR CH 5.1PF		EA	1.00	1.00	1.00
C	69	106-00072-0026	CAP CH 27PFNPO/50V		EA	1.00	1.00	1.00
C	70	106-00072-0012	CAP CH12PF NPO/50V		A	EA	1.00	1.00

FRONT COVER ASSEMBLY

200-03477-0004 EPH 514 0M
 200-03477-0005 EPH 599 1M
 200-03477-0006 EPH 502 0A, 514 0A
 200-03477-0007 EPH 514 1A, 542 1A, 599 1A, 599 1K
 200-03477-0008 EPH 214 2A
 200-03477-0009 EPH 599 SL
 200-03477-0010 EPH 599 2A
 200-03477-0020
 200-03477-0021 EPH 514 2M

SYMBOL	PART NUMBER	DESCRIPTION	A	UM	QUANTITY										
					0004	0005	0006	0007	0008	0009	0010	0020	0021		
	200-03477-0099	COMMON BOM	A	EA	1.00	1.00	1.00	1.00	1.00	1.00	1.00	1.00	1.00	1.00	
ASY 1	200-06907-0020	OPTION BD ASSY	A	EA	1.00	1.00	1.00	1.00	1.00		1.00	1.00	1.00	1.00	
ASY 1	200-06248-0000	UCOM BD	A	EA						1.00					
ASY 2	200-03223-0005	KBD/DSPL ASSY MOD	A	EA		1.00		1.00							
ASY 2	200-03223-0021	ALPHA DSPL ASSY	A	EA					1.00					1.00	
ASY 2	200-03223-0022	ALPHA DSPL ASSY	A	EA						1.00	1.00				
ITM 1	073-00613-0001	FRT CVR INSERT W/F	A	EA	1.00								1.00		
ITM 1	088-01315-0000	INSRT FRNT CVR BLK		EA			1.00								
ITM 2	091-00408-0000	SPACER BD		EA	1.00		1.00						1.00		
ITM 4	088-02080-0002	GOLD INLY NAMEPLT		EA	1.00	1.00	1.00	1.00	1.00	1.00	1.00	1.00	1.00	1.00	
ITM 5	073-00893-0001	COVER W/FINISH	A	EA	1.00	1.00							1.00	1.00	
ITM 5	088-02095-0002	FRONT COVER EPH		EA			1.00	1.00	1.00	1.00	1.00	1.00			
ITM 15	089-06615-0008	SCR PHP M2.0 X 08	A	EA	4.00								4.00		
ITM 15	089-07075-0000	SCR PHP 2-28	A	EA		4.00	4.00	4.00	4.00	4.00	4.00	4.00		1.00	
ITM 17	088-01306-0000	DOOR KEYBOARD BLK	A	EA		1.00		1.00	1.00	1.00	1.00			1.00	

J K FLIP-FLOP

The flip-flop logic element is the basic data storage element of digital logic. It has two outputs that are always at opposite logic levels. That is, when one output is HI the other is LO. The flip-flop will remain in a particular state until that state is changed by an input signal.

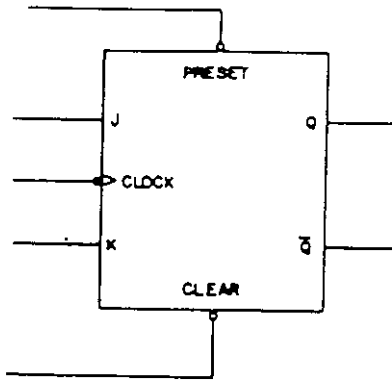

J	K	Q	\bar{Q}
L	L	Q_0	\bar{Q}_0
H	L	H	L
L	H	L	H
H	H	Toggle	Toggle

BASIC OP-AMP CIRCUITS

LIMITER

An output voltage may be limited to certain levels by selection appropriate zener diodes and placing them in parallel with the feedback resistor. Voltage limiting can be accomplished in both directions in this manner.

$$V_o (\text{max}) = V_z + V_f$$

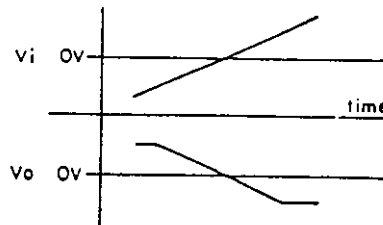
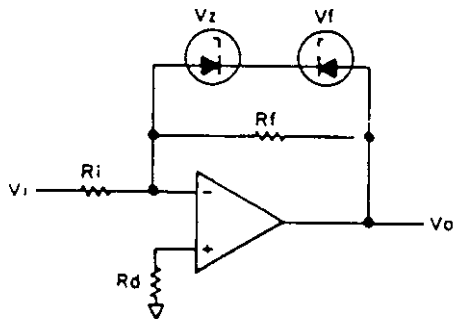

OPTIONS BOARD

200-06907-0020

SYMBOL	PART NUMBER	DESCRIPTION	A	UM	QUANTITY
					0020
C	1	106-04102-0047		EA	1.00
C	2	106-04561-0014		EA	1.00
C	3	106-04104-0047		EA	1.00
C	4	106-04561-0014		EA	1.00
C	5	106-04182-0014		EA	1.00
C	6	106-04182-0014		EA	1.00
C	7	106-00077-0000	A	EA	1.00
C	8	106-00077-0000	A	EA	1.00
C	9	106-04103-0046		EA	1.00
C	10	106-04103-0046		EA	1.00
C	11	106-04152-0016		EA	1.00
C	12	096-01186-0062		EA	1.00
C	13	096-01186-0064		EA	1.00
C	14	106-04104-0047		EA	1.00
C	15	096-01186-0028	A	EA	1.00
C	16	106-04104-0047		EA	1.00
C	17	106-04272-0046		EA	1.00
C	18	106-04103-0046		EA	1.00
C	19	106-04103-0046		EA	1.00
C	20	106-04272-0046		EA	1.00
C	21	106-04822-0046		EA	1.00
C	22	106-04151-0016		EA	1.00
C	26	106-04104-0047		EA	1.00
C	30	106-04102-0047		EA	1.00
C	31	106-04102-0047		EA	1.00
C	32	106-04102-0047		EA	1.00
C	33	106-04102-0047		EA	1.00
C	34	106-04104-0047		EA	1.00
C	35	106-04333-0046		EA	1.00
C	36	106-04222-0046		EA	1.00
C	37	106-04563-0046		EA	1.00
C	38	106-04101-0047		EA	1.00
C	40	106-04101-0047		EA	1.00
C	41	106-04104-0047		EA	1.00
C	42	106-04101-0047		EA	1.00
C	45	106-04101-0016		EA	1.00
C	46	106-04101-0047		EA	1.00
C	47	106-04101-0016		EA	1.00
C	51	106-04471-0026		EA	1.00
C	52	106-04101-0047		EA	1.00
C	53	106-04101-0047		EA	1.00
C	54	106-04101-0047		EA	1.00
C	55	106-04101-0047		EA	1.00
C	56	106-04101-0047		EA	1.00
C	57	106-04101-0047		EA	1.00
C	58	106-04101-0047		EA	1.00
C	59	106-04101-0047		EA	1.00
C	60	096-01186-0064		EA	1.00
C	61	106-04101-0047		EA	1.00
C	62	106-04101-0047		EA	1.00
C	63	106-04101-0047		EA	1.00
C	64	106-04101-0047		EA	1.00
C	65	106-04101-0047		EA	1.00
C	66	106-04101-0047		EA	1.00
C	67	106-04101-0047		EA	1.00
C	68	106-04391-0016		EA	1.00
C	69	111-00001-0094		EA	1.00
CR	1	007-06181-0000	A	EA	1.00
I	1	120-03196-0000	A	EA	1.00
I	2	120-03426-0000	A	EA	1.00
I	3	120-03195-0000		EA	1.00
I	4	120-06131-0001	A	EA	1.00
ITM	1	009-06907-0020	A	EA	1.00
ITM	6	012-01440-0000		EA	1.00
J	9	030-01249-0004		EA	8.00
J	10	030-02905-0007		EA	1.00
P	7	030-03053-0006		EA	1.00
P	8	030-03053-0005		EA	1.00

INVERTING OP-AMP AMPLIFIER

A voltage applied at the inverting (-) input will cause an output voltage (Vo) of opposite polarity as the applied voltage. The relationship of the input and output voltages is shown in the following equations:

$$V_o = (R_f/R_i) V_i$$

$$\text{GAIN} = -(R_f/R_i)$$

From the above equation, a zero input voltage should give a zero output if Rn has been adjusted to the null of the amplifier.

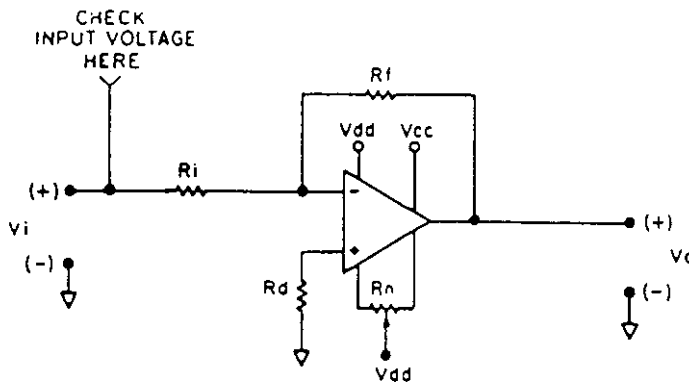

NON-INVERTING OP-AMP AMPLIFIER

A voltage applied at the non-inverting (+) input will cause an output voltage (Vo) of the same polarity as the applied voltage. The relationship of the input and output voltages is shown in the following equations:

$$V_o = [1 + (R_f/R_i)] V_i$$

$$\text{GAIN} = 1 + (R_f/R_i)$$

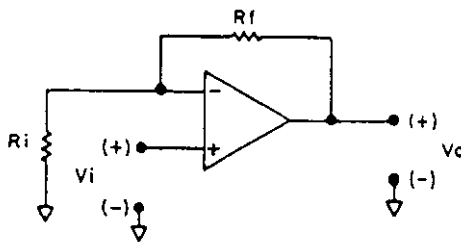

KEYBOARD/DISPLAY ASSEMBLY

200-03223-0000
 200-03223-0005 EPH 514 1A, 542 1A, 599 1A, 599 1K, 599 1M, 599 2D, 599 DM
 200-03223-0006
 200-03223-0020
 200-03223-0021 EPH 214 2A, 514 2M
 200-03223-0022 EPH 599 2A, 599 SL, 599 SM

SYMBOL	PART NUMBER	DESCRIPTION	A	UM	QUANTITY				
					0005	0006	0020	0021	0022
ASY 1	200-06878-0001	KYBD/DSPL BD TONE	A	EA	1.00	1.00			
ASY 1	200-06924-0010	ALPHA DSPL 2 GRP	A	EA			1.00		
ASY 1	200-06924-0011	ALPHA DSPL 2 GRP	A	EA				1.00	
ASY 1	200-06924-0012	ALPHA DSPL BD 15GR	A	EA					1.00
ITM 1	030-02530-0000	ZEBRA CONNECTOR		EA			1.00	1.00	1.00
ITM 1	030-03025-0000	LCD CONNECTOR	A	EA	1.00	1.00			
ITM 2	031-00472-0005	KEYPAD BLK	A	EA	1.00	1.00	1.00	1.00	1.00
ITM 3	043-00011-0002	LAND MOBILE LCD		EA	1.00	1.00			
ITM 3	043-00012-0000	EPH LCD	A	EA			1.00	1.00	1.00
ITM 4	057-02846-0000	OVERLAY KYBD BLK		EA	1.00	1.00	1.00	1.00	1.00
ITM 5	088-02074-0000	DISPLAY LENS		EA	1.00	1.00			
ITM 6	088-02079-0010	KYBD DISP MOD	A	EA	1.00	1.00			
ITM 6	088-02079-0020	INSERT ASSY	A	EA			1.00	1.00	1.00
ITM 7	088-02096-0001	LIGHT PIPE	A	EA			1.00	1.00	1.00
ITM 7	187-01325-0000	DISPLAY SPACER		EA	1.00	1.00			
ITM 8	089-06297-0003	SCR FHP 2-56X3/16	A	EA	3.00	3.00	3.00	3.00	3.00
ITM 9	012-01463-0000	INSUL KYBD		EA	1.00	1.00			
ITM 10	047-09106-0000	SHIELD FOIL TAPE		EA	1.00	1.00			
ITM 11	047-09724-0000	CLIP	A	EA			1.00	1.00	1.00
ITM 12	012-01517-0000	DIFFUSER MYLAR	A	EA			1.00	1.00	1.00
REF 1	300-03223-0000	KBD/DSPLY ASSY		RF	X.	X.			
REF 1	300-03223-0020	ALPHA DSPL ASSY	A	RF			X.	X.	X.

THRESHOLD DETECTOR

Threshold detectors use positive feedback to toggle the op-amp output when the input voltage (V_i) is above or below a voltage level ($V_{THRESHOLD}$) set by R_2 and R_3 . R_4 provides the positive feedback required for a clean switch from one saturation level to another. The voltage polarity (V_A) determines the initial output state of the amplifier and the polarity of the threshold being detected.

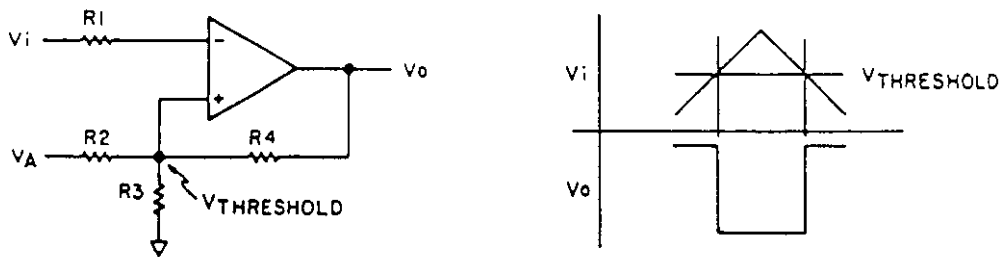

DIFFERENTIAL AMPLIFIER

The principal use of the differential amplifier is to translate signals, from sources referenced to some level other than signal ground, to signals referenced to signal ground. The relationship of the input and output voltages is shown in the following equations:

$$V_o = -(R_f/R_i) V_i, \text{ if } R_1 = R_3 \text{ and } R_2 = R_4$$

$$\text{GAIN} = -(R_f/R_i)$$

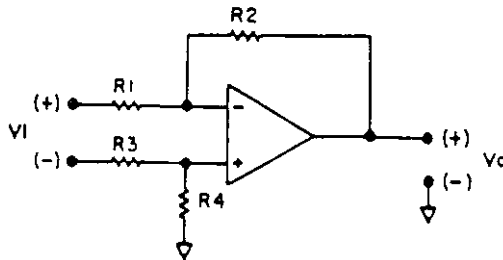

FCC ID: K95GPH51

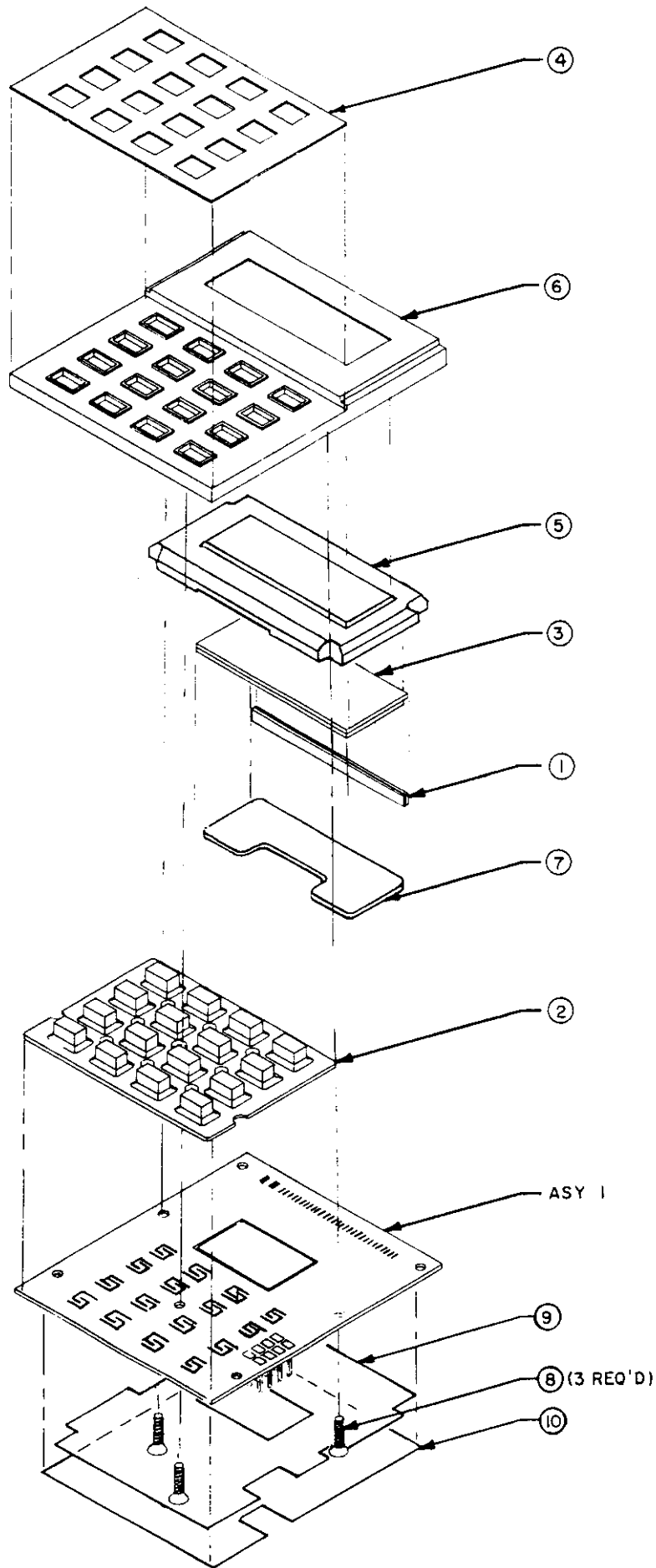

SURFACE MOUNT COMPONENTS (CON'T)

The illustrations below show acceptable ways of mounting flat leaded components.

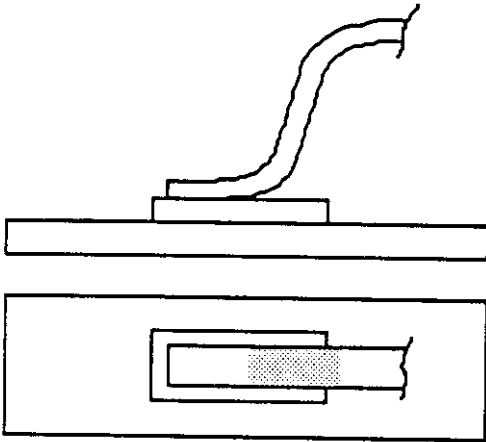

PREFERRED

Lead is centered within the confines of the pad.

Heel rises before leaving pad area.

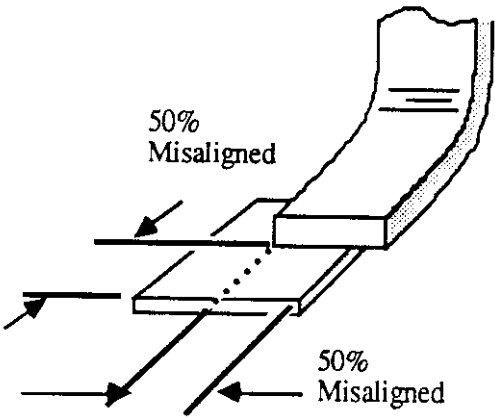

MINIMUM ACCEPTABLE

Lead misalignment is not more than 50%.

APPENDIX A INTEGRATED CIRCUIT DATA

INTRODUCTION

This appendix contains descriptions of certain integrated circuits as an aid to understanding the operation of this equipment. Detailed information on IC's containing basic logic elements, op-amps, and other simple circuits are not included in this appendix as their theory of operation is summarized below and the operation of such circuits within this equipment may be readily understood from a review of this summary and the schematic diagrams included in Section VI of this manual.

BASIC LOGIC ELEMENTS

BUFFER



$$Z = A$$

A	Z
0	0
1	1

INVERTER



$$Z = \bar{A}$$

A	Z
0	1
1	0

OR GATE



$$Z = A+B+C$$

A	B	C	Z
0	0	0	0
1	0	0	1
0	1	0	1
0	0	1	1
1	1	0	1
1	0	1	1
0	1	1	1
1	1	1	1

NOR GATE



$$Z = \overline{A+B+C}$$

A	B	C	Z
0	0	0	1
1	0	0	0
0	1	0	0
0	0	1	0
1	1	0	0
1	0	1	0
0	1	1	0
1	1	1	0

AND GATE



$$Z = ABC$$

A	B	C	Z
0	0	0	0
1	0	0	0
0	1	0	0
0	0	1	0
1	1	0	0
1	0	1	0
0	1	1	0
1	1	1	1

NAND GATE



$$Z = \overline{ABC}$$

A	B	C	Z
0	0	0	1
1	0	0	1
0	1	0	1
0	0	1	1
1	1	0	1
1	0	1	1
0	1	1	1
1	1	1	0

EXCLUSIVE OR GATE



$$Z = A \oplus B$$

A	B	Z
0	0	0
1	0	1
0	1	1
1	1	0

SURFACE MOUNT COMPONENTS (CON'T)

The following illustrations show acceptable solder height, amount of fillet, conductor spacing, and amount of allowable chip float.

The illustrations below show acceptable fillet heights.

TOP VIEW



PREFERRED

Solder fillet height is 30% of the end height.

SIDE VIEW



There is complete wetting of the pad and device end termination.

When the chips are wave soldered, it is permissible for the solder to come to the top or even over the cap of the end termination.

TOP VIEW



ACCEPTABLE

Solder fillet height is to the top of the end termination.

SIDE VIEW



There is good wetting.

TOP VIEW

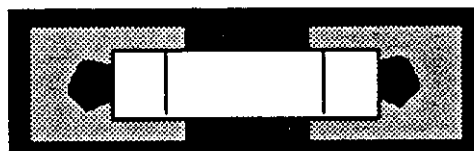

MINIMUM
ACCEPTABLE

The fillet height is 10% of the end termination.

SIDE VIEW



There is incomplete wetting of the pad and termination.

INTEGRATOR

An op-amp in which the only feedback element is a capacitor. The output of an integrator is a ramp, the slope of which is determined by the amplitude of the steady state input and the RC time constant.

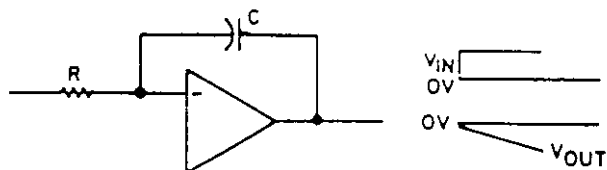

ZERO CROSSING DETECTOR

The positive feed back path causes the output voltage to drive to the saturation potential of opposite polarity as the input voltage. Ideally, the output switches from one saturation level to the opposite saturation level as the input voltage passes through zero. Noise immunity demands the addition of R_B which requires that the input reach a certain magnitude after passing zero before the output will switch.

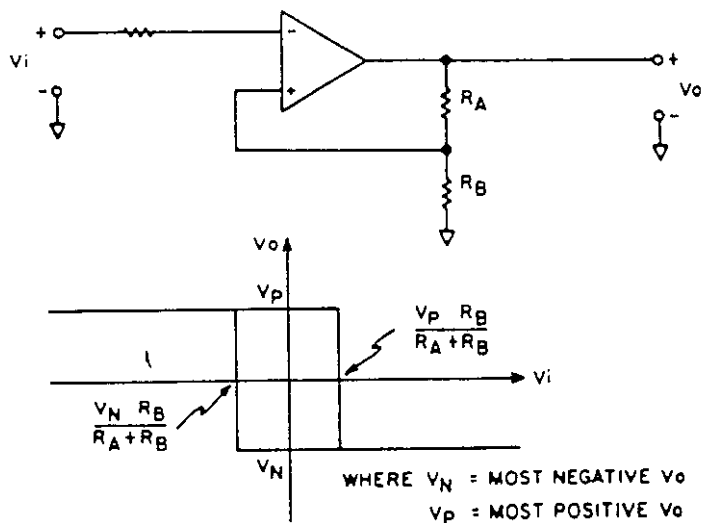

SURFACE MOUNT COMPONENTS (CON'T)

The two illustrations below show acceptable conductor spacing after solder flow. The spacing is not less than 50% of the original width or less than 0.005".

PREFERRED

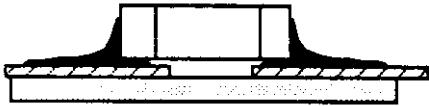

The solder holds the chip to the pads and normal conductor spacings are maintained.

MINIMUM ACCEPTABLE



The spacing between the pads is reduced to 50% of the original spacing.

The illustration below shows an unacceptable chip component, where the spacing between pads is reduced by more than 50% because of excess solder. This component must be reworked.

REWORK - UNACCEPTABLE



The spacing between the pads is reduced by more than 50% because of excess solder.

LOW PASS FILTER

The low pass filter is a variation of an inverting op-amp circuit. The addition of capacitor C_f to the feedback network around the amplifier provides low pass filtering to the input voltage. The expression $T = RfC_f$ gives the time required for V_o to reach 63% of the final value.

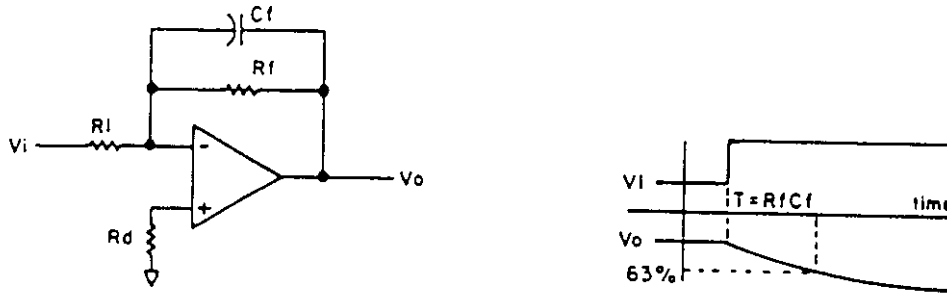

VOLTAGE FOLLOWER AMPLIFIER

This configuration is a special case of the non-inverting amplifier previously discussed, with R_f equal to zero. Therefore the relationship of the input and output voltage reduces to $V_o = V_i$, or unity gain. It is used to provide high input impedance and buffering action.

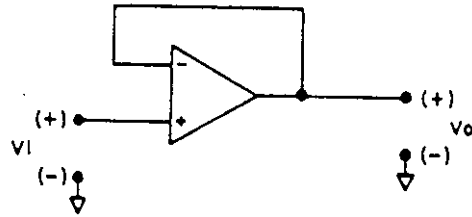

SURFACE MOUNT COMPONENTS (CON'T)

The criteria for acceptable and unacceptable end conditions in chip components are listed below.

You cannot have more than 20% of any one of the surfaces of the end termination removed as a result of the soldering operation.

The end termination consists of five surfaces.

- a. top
- b. bottom
- c. left side
- d. right side
- e. face

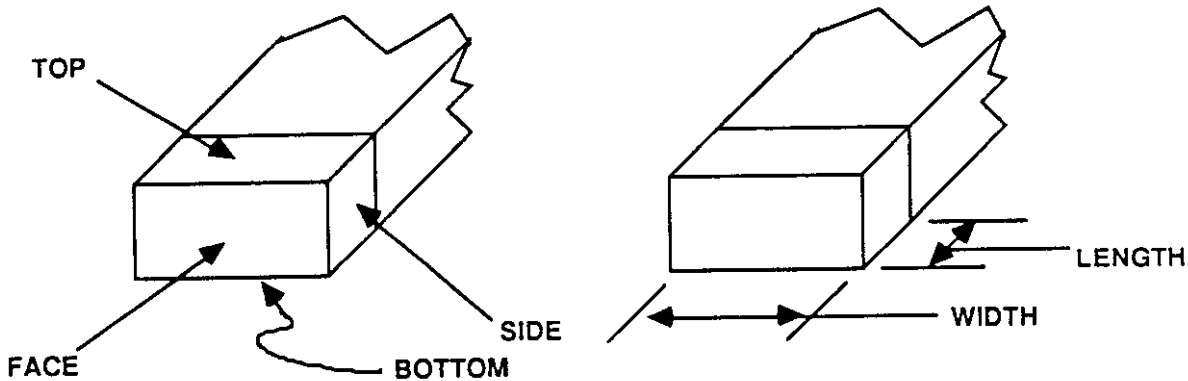

There shall be no visible evidence of a fractured solder connection.

Voids and pin holes are acceptable if the bottom of the hole is visible and good wetting is present - the fillet should be concave.

All deposits or residues of activated, RA, fluxes must be removed.

SURFACE MOUNT COMPONENTS

Round leaded and flat leaded components can be mounted on the surface of a board rather than through plated holes on a board.

The illustrations below demonstrate acceptable mounting practices for round leaded components on surface mount boards.

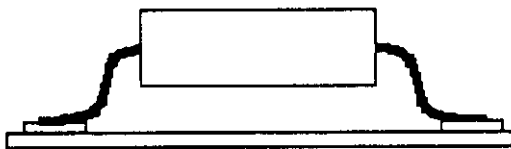

PREFERRED

Lead is centered on the pad. At least 0.040" (the thickness of a dime) is in contact with the pad. The lead does not overhang the pad.

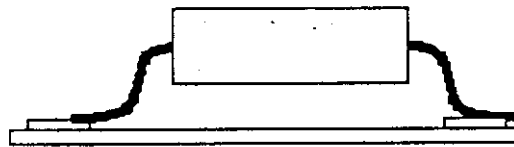
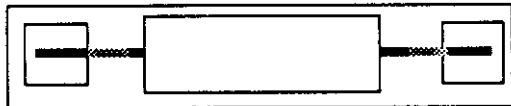

ACCEPTABLE MINIMUM

The lead has a minimum of contact area and has a slight overhang. The lead is not centered on the pad. The lead is at the edge of the pad. The contact area is not less than 0.040".

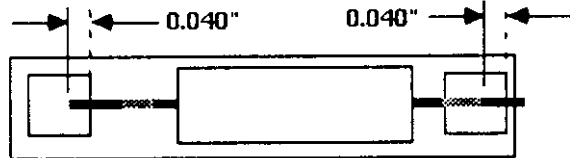

SURFACE MOUNT COMPONENTS (CON'T)

The length part of the solderable end cap of the device should overlap the mounting pad by at least 0.010" (the thickness of two pieces of notebook paper).

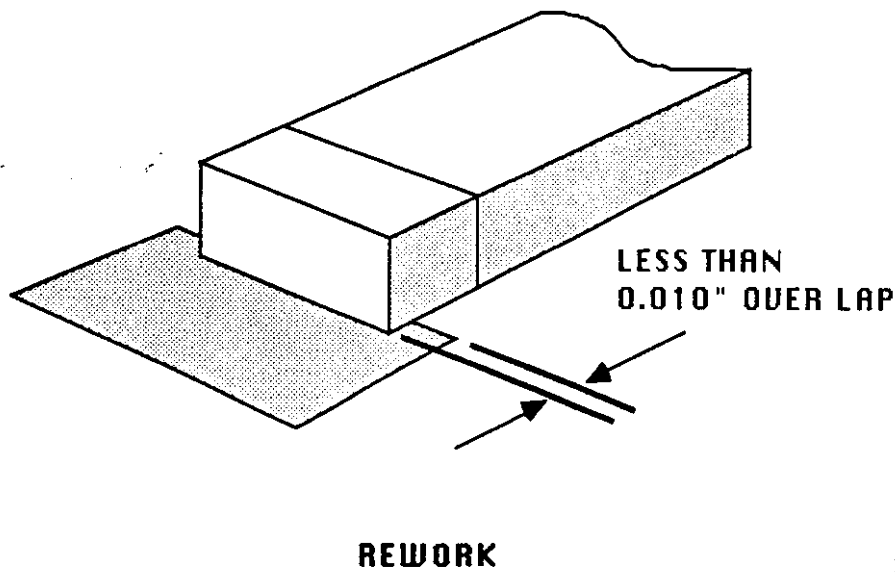
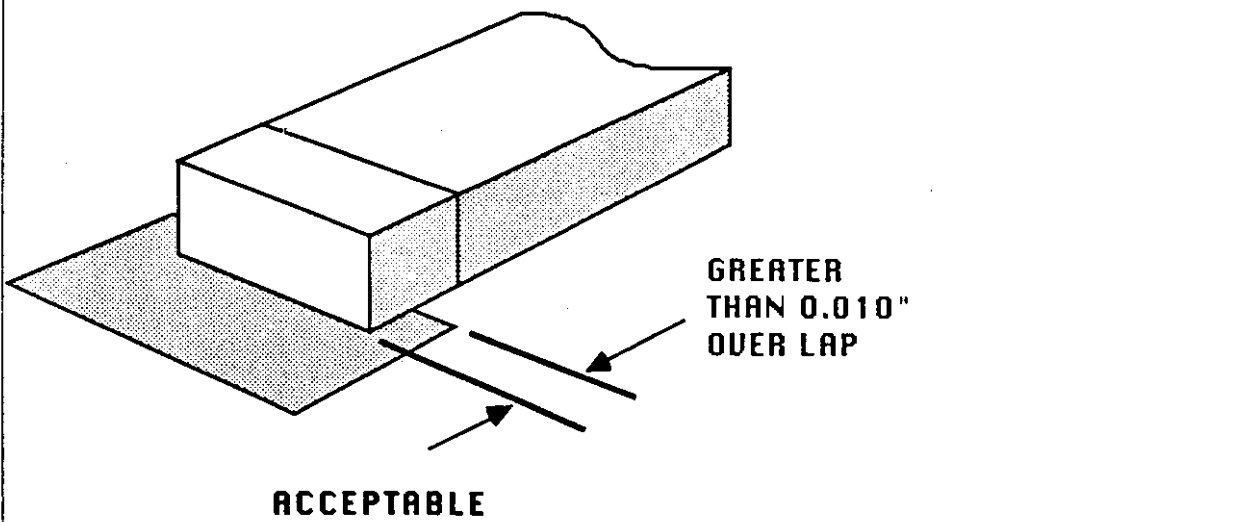

SURFACE MOUNT COMPONENTS (CON'T)

The illustration below shows an unacceptable way of mounting a flat leaded component.

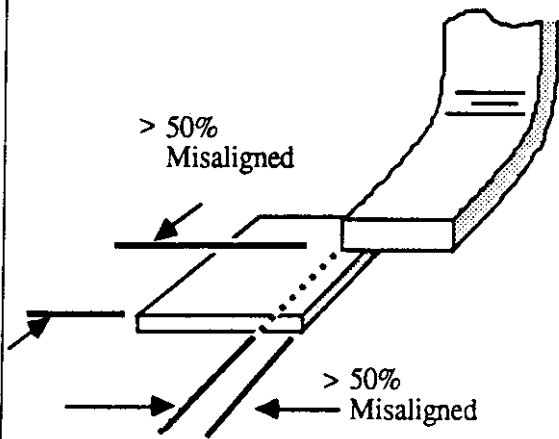

UNACCEPTABLE - REWORK

Lead is misaligned with the side of the pad or the length of the pad by more than 50%.

SURFACE MOUNT COMPONENTS (CON'T)

The illustration below shows an unacceptable amount of misalignment that should be reworked.

RESIST

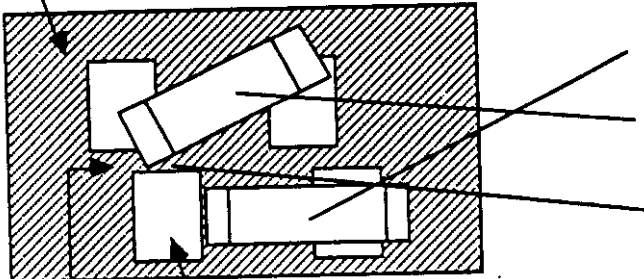

MISSED PAD

**LESS THAN 0.010" CLEARANCE,
POTENTIAL SHORT**

REWORK

The part does not overlap the pads.

Misalignment exceeds 50% of the width of the pad.

Poor positioning creating a potential short (closer than 0.010" - the thickness of two sheets of paper).

SURFACE MOUNT COMPONENTS (CON'T)

The illustrations below show acceptable amounts of solder applied to surface mount chips.

PREFERRED

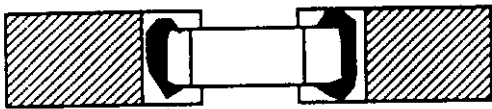

The solder fillet is continuous around the perimeter of the chip termination.

There is good wetting of the land and termination.

Fillet height is approximately 30% of the termination height.

MINIMUM ACCEPTABLE

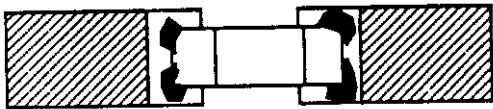

There is 50% solder coverage of the perimeter of the chip.

The fillet height is at least 10% of the termination height.

The illustration below shows a chip component that should be reworked because of insufficient solder. There is less than 50% solder coverage around the perimeter and bottom of the chip.

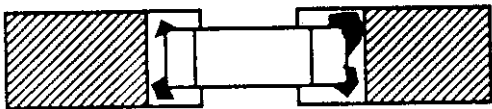

UNACCEPTABLE - REWORK

There is less than 50% solder coverage on the perimeter of the chip.

There is less than 50% solder coverage on the bottom of the chip.

The solder fillet is insufficient.

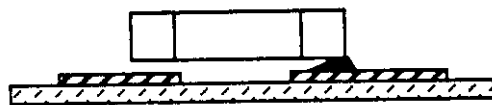

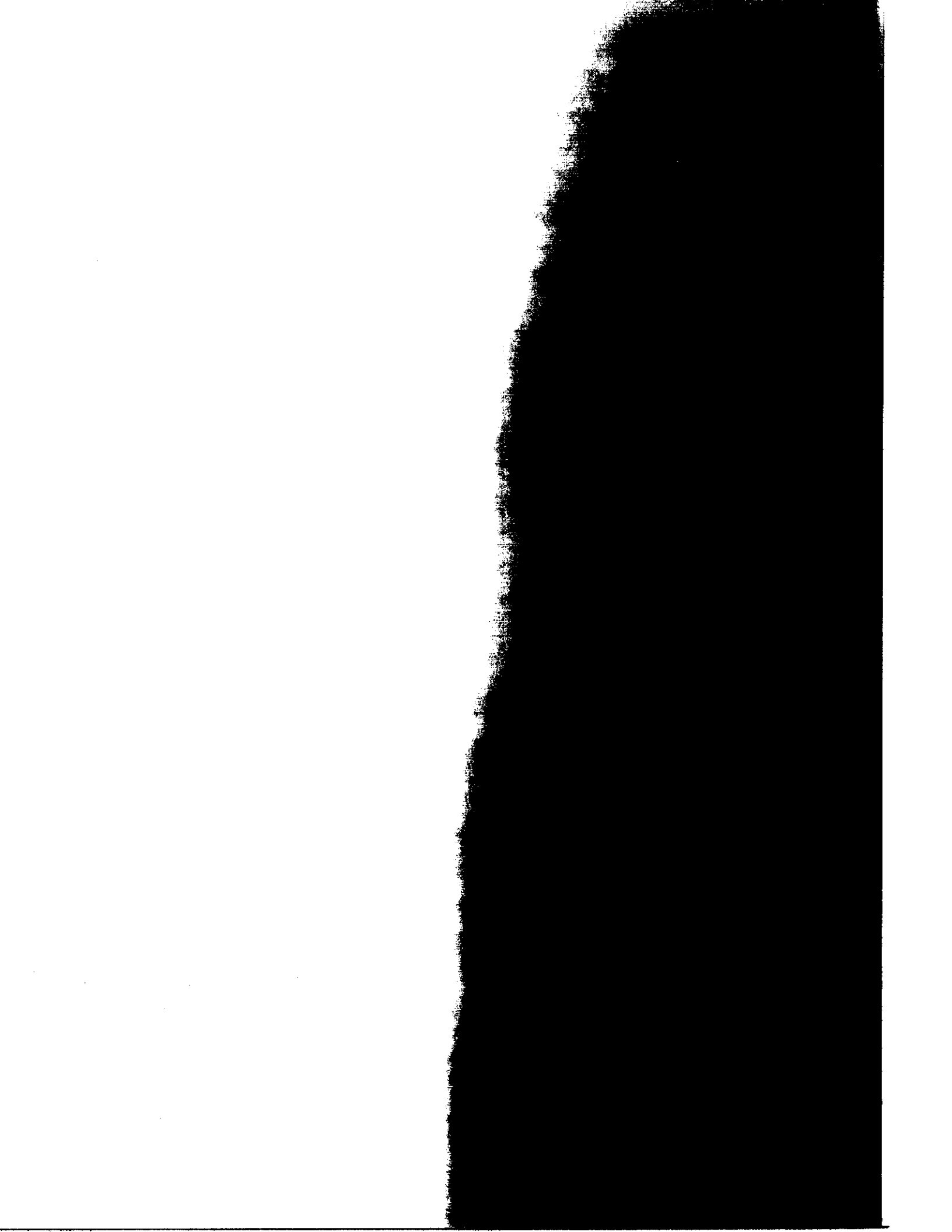

SURFACE MOUNT COMPONENTS (CON'T)

The illustrations below show acceptable components that have not floated higher than 0.020" above their pads.

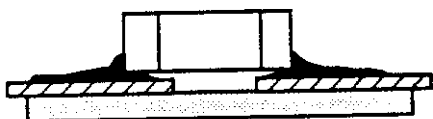

PREFERRED
 The solder height is minimal.
 The fillet is concave.
 There is good wetting.
 The chip is raised less than 0.020".

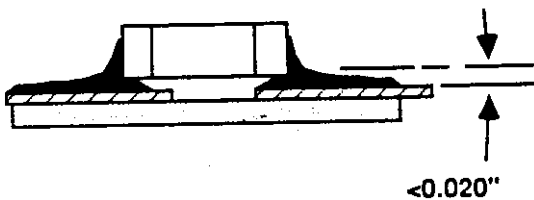

ACCEPTABLE
 The solder has floated the chip off its adhesive (if used) but the amount of float is not greater than 0.020".



SURFACE MOUNT ASSEMBLIES (CON'T)

On mini-mica chip capacitors, the solder fillet shall be continuous on two sides for at least 50% of the component width.

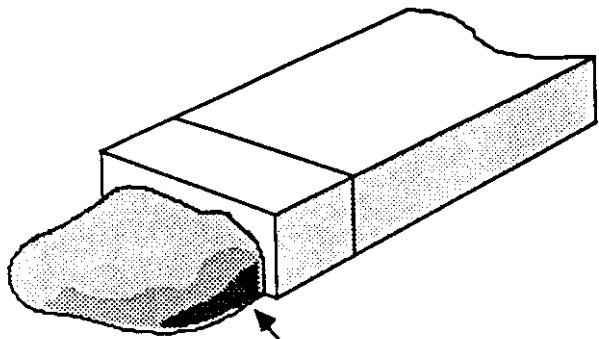

**GREATER THAN 50% COVERAGE
OF CHIP WIDTH**

ACCEPTABLE

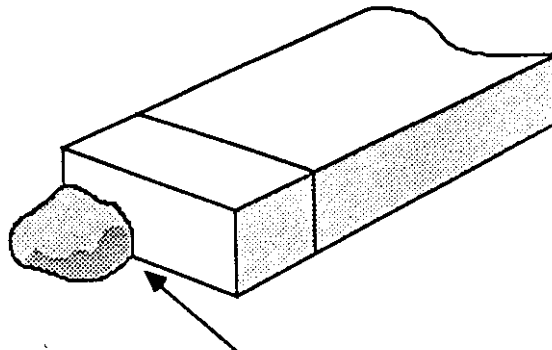

**LESS THAN 50% COVERAGE
OF CHIP WIDTH**

REWORK

Voids are permissible up to 80% of the coverage requirement.

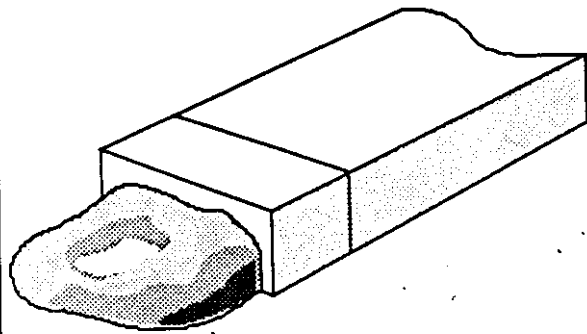

**VOID IS LESS THAN 80%
OF THE SOLDER WIDTH**

ACCEPTABLE

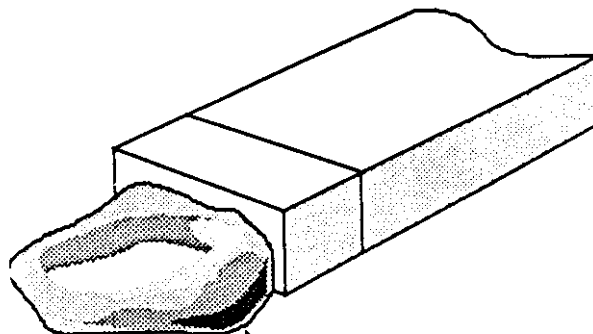

**VOID IS GREATER THAN 80%
OF THE SOLDER WIDTH**

REWORK

The minimally acceptable fillet shall rise from the pad to the edges of the capacitor that normally contacts the board and shall show a concave fillet.

1.4 TECHNICAL CHARACTERISTICS

FREQUENCY:	148-174 MHz (EPH) 136-160 MHz (EPI)
POWER SUPPLY:	One rechargeable nickel-cadmium battery pack with temperature sensor or one Alkaline battery pack
OPERATIONAL FEATURES:	
Priority Channel Scan	Programmable*
Transmit-Time-Out Timer	Programmable*
Scan Delay	Programmable*
DTMF/ANI Encode	Programmable*
Code Guard Squelch	Programmable*
Squelch Tail Elimination	Standard
	* Keyboard units only
CHANNELS:	14, or 210 in fifteen 14-channel groups
FREQUENCY SPREAD:	26 MHz with no degradation
CHANNEL SPACING:	
Flex-Mode:	12.5/15 or 25/30 KHz Programmable by channel
Non-Flex-Mode:	25/30 KHz
OPERATING TEMPERATURE:	-30° to +60°c

PHYSICAL DIMENSIONS

Weight:	20 oz (24 oz with large battery) 0.6 kg (0.7 kg with large battery)
Width:	2.55 in (64.8 mm)
Depth:	1.5 in (38.1 mm)
Height:	6.6 in (167.6 mm) 7.8 in (198.1 mm) with large battery)
ANTENNA TYPE:	Threaded Helical wound rubber flex (standard) BNC Helical wound rubber flex (optional)
CHANNEL SPACING:	30 KHz
MAX CURRENT DRAIN:	
Transmit 5 watt:	1.4 amps
Receive:	165 mA
Receive standby:	45 mA (battery save off) 15 mA (battery save on)
FCC Identification number:	K95 LT 2002

SURFACE MOUNT COMPONENTS (CON'T)

The illustrations below show the amount of chip misalignment that is acceptable.

The length part of the solderable end cap of the device should not be misaligned with the mounting pad by more than 50% of its length.

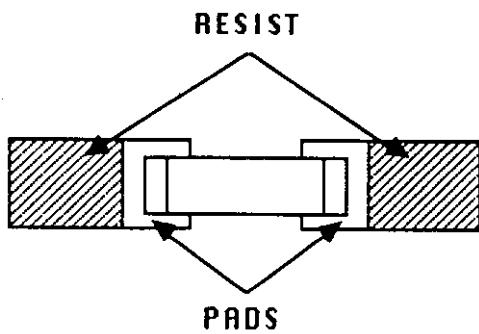

PREFERRED

The part is evenly aligned between the two conductor lands (solder is not shown).

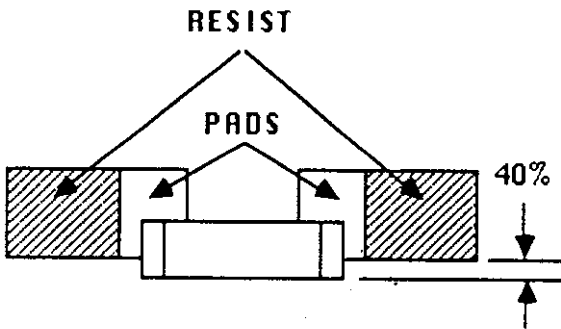

MINIMUM ACCEPTABLE

Part misalignment does not exceed 40% of the width.

Part overlap on the pads is not less than 0.010".

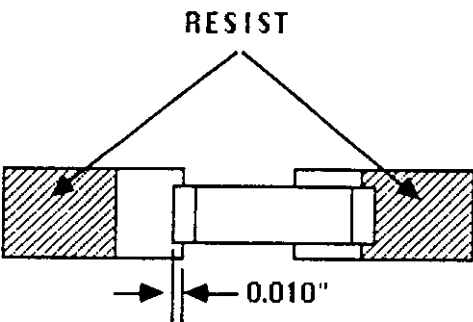

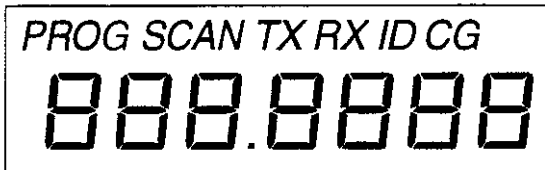
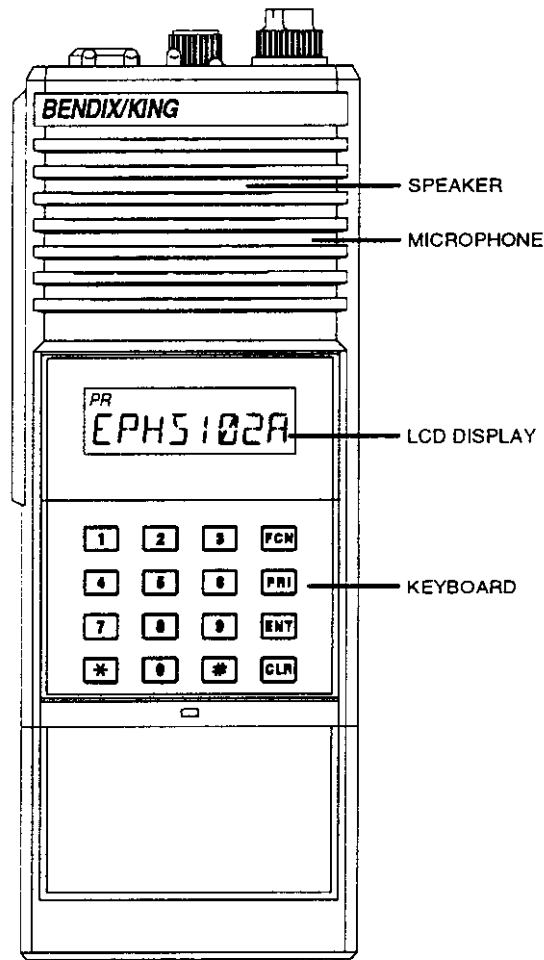
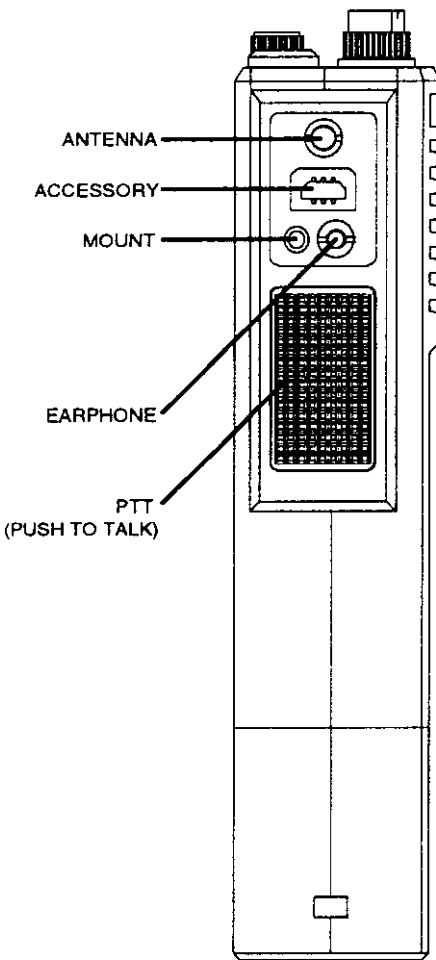
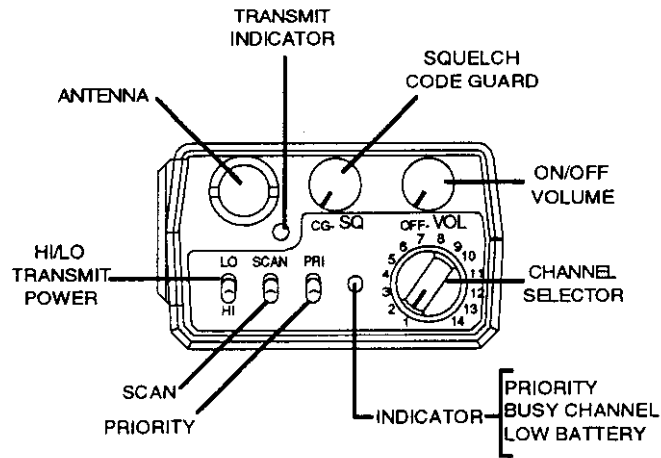
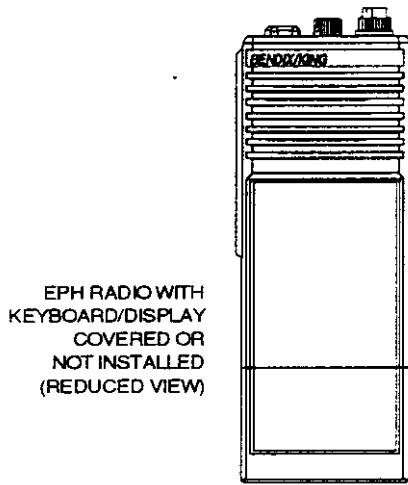

7-SEGMENT DISPLAY

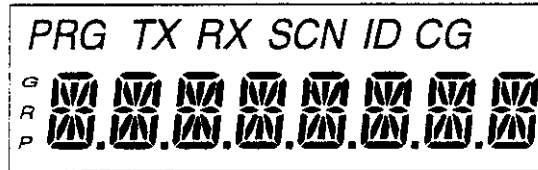

ALPHANUMERIC DISPLAY

FIGURE 1-1 CONTROLS

FCC ID: K95GPH51

BENDIX/KING

Mobile Communications Division
2920 Haskell Avenue
Lawrence, Kansas 66046
Telephone: (913) 842-0402
Telex: 669916 KINGRAD UW
FAX: (913) 841-0287

© Copyright 1991 BENDIX/KING. All rights reserved.

SYSTEMS BOARD (FLEX)

200-08822-0000
200-08822-0030
PAGE 2

EPH
EPI

SYMBOL	OLD PART NO.	NEW PART NO.	DESCRIPTION	A	UM	EPH	EPI
C	66	106-05102-0016	1553-5313-582	CAP CH 1K NPO/50V	EA	1.00	1.00
C	67	106-05102-0016	1553-5313-582	CAP CH 1K NPO/50V	EA	1.00	1.00
C	69	096-01186-0062	1552-6463-121	CAP 1.0UF 16V 20%	EA	1.00	1.00
CJ	1	130-05000-0015	4724-0000-009	RES CH 0 TW	EA	1.00	1.00
CJ	2	130-05000-0015	4724-0000-009	RES CH 0 TW	EA	1.00	1.00
CJ	3	130-05000-0015	4724-0000-009	RES CH 0 TW	EA	1.00	1.00
CJ	10	130-05000-0015	4724-0000-009	RES CH 0 TW	EA	1.00	1.00
CJ	10	130-05104-0013	4724-0104-233	RES CH 100K TW 5%	EA	1.00	1.00
CJ	11	130-05153-0013	4724-0153-233	RES CH 15K TW 5%	EA	1.00	1.00
CR	1	007-04066-0000	4824-2021-200	DIODE DUAL VAR	EA	1.00	1.00
CR	2	007-04066-0000	4824-2021-200	DIODE DUAL VAR	EA	1.00	1.00
CR	3	007-06178-0000	4824-5483-300	DIO PIN MMBV3401	EA	1.00	1.00
CR	4	007-04133-0000	4824-2021-600	DIODE VARACTOR	EA	1.00	1.00
CR	5	007-04057-0000	4824-2021-100	DIO V MMBV105G	EA	1.00	1.00
CR	6	007-06184-0000	4824-2008-500	DIO DUAL SWITCHING	EA	1.00	1.00
CR	7	007-06176-0003	4810-2009-301	DIO MV5774C	EA	1.00	1.00
CR	8	007-06184-0000	4824-2008-500	DIO DUAL SWITCHING	EA	1.00	1.00
I	1	122-05001-0004	3134-2095-000	LMR EPH PROCESSOR	A	EA	1.00
I	1	122-05030-0001	7019-2061-801	EPHCOMB1	A	EA	1.00
I	2	120-06056-0003	3134-2040-800	4094(SO) REGISTER	EA	1.00	1.00
I	3	120-03476-0000	3134-3670-409	OP AMP	EA	1.00	1.00
I	4	120-03477-0000	3134-2061-600	OP AMP	EA	1.00	1.00
I	5	120-06084-0003	3134-2061-700	HEX 3 STATE BUFFER	EA	1.00	1.00
I	6	120-06096-0002	3134-2010-100	IC 14504B SO1C	EA	1.00	1.00
I	7	120-02163-0000	3134-2040-000	EEPROM 2048X8 BIT	EA	1.00	1.00
I	8	120-03274-0000	3134-3670-403	VOLT REG LM2951ACM	EA	1.00	1.00
I	9	120-03428-0000	3134-2048-800	AUD AMP SL6310L/MP	EA	1.00	1.00
I	10	123-00074-0003	3134-3670-507	IC 74HC74 SO PKG	EA	1.00	1.00
I	11	120-00203-0002	3134-2061-400	VHF PRESCALER	EA	1.00	1.00
I	12	120-06132-0002	3134-2010-200	IC FREQ SYN	EA	1.00	1.00
I	13	120-06131-0000	3134-3670-505	IC QUAD ANLG SW	EA	1.00	1.00
I	14	120-06131-0000	3134-3670-505	IC QUAD ANLG SW	EA	1.00	1.00
I	15	120-03460-0000	3134-2061-500	LOW VOLT AMP	EA	1.00	1.00
ITM	1	009-08822-0000	1700-6706-100	PC BD SYS CONFIG	EA	1.00	1.00
ITM	2	195-00126-0000	0011-2075-800	CRYSTAL KIT	EA	1.00	1.00
ITM	3	016-01124-0005	1601-2000-906	FOAM TAPE	IN	0.50	0.50
ITM	4	026-00030-0000	6024-0000-001	WIRE CU24AWG TIN	IN	2.00	2.00
ITM	5	016-01184-0000	1609-0000-004	ELASTOMERIC ADHES	AR	1.00	1.00
ITM	6	016-01124-0003	1601-2000-904	FOAM TAPE .38W	IN	0.50	0.50
ITM	7	047-09532-0000	2508-4008-800	FENCE ASSY	EA	1.00	1.00
ITM	8	013-00175-0000	2500-2061-300	THREADED CORE	EA	1.00	1.00
ITM	9	150-00003-0010	3101-0000-013	TUBING TFLN 24AWG	IN	0.25	0.25
J	7	030-03052-0006	2105-2017-606	BOX CONN STRIP	EA	1.00	1.00
J	8	030-03052-0006	2105-2017-606	BOX CONN STRIP	EA	1.00	1.00
L	1	019-02660-0017	1808-2013-617	IND SM 220 NH	EA	1.00	1.00
L	2	019-02660-0014	1808-2013-614	INDUCT SURFACE MT	EA	1.00	1.00
L	3	019-02660-0018	1808-2013-618	INDUCT SURFACE MT	EA	1.00	1.00
L	4	019-02660-0019	1808-2013-619	INDUCT SURFACE MT	EA	1.00	1.00
L	5	019-02660-0028	1808-2013-628	INDUCT SURFACE MT	EA	1.00	1.00
L	6	019-02660-0028	1808-2013-628	INDUCT SURFACE MT	EA	1.00	1.00
P	1	030-02219-0021	2105-2035-821	HEADER STRT 3P	EA	1.00	1.00
P	2	030-03053-0004	2105-2035-704	2500 SQ TERM STRIP	EA	1.00	1.00
Q	1	007-00537-0000	4823-3741-301	XSTR PNP MMBT5087	EA	1.00	1.00
Q	2	007-00539-0000	4823-1367-900	XSTR MMBTH10	EA	1.00	1.00
Q	3	007-00536-0000	4823-2008-100	XSTR MMBR920	EA	1.00	1.00
Q	4	007-00539-0000	4823-1367-900	XSTR MMBTH10	EA	1.00	1.00
Q	5	007-00187-0002	4823-3741-401	XSTR SOT-23 2N5089	EA	1.00	1.00
Q	6	007-08064-0014	4823-2010-814	XSTR PNP 4.7K, 10K	EA	1.00	1.00

BENDIX/KING
SERVICE MANUAL UPDATE

Date: March 1995

Model: EPH and EPI Series portable radios

Reference: EPH Series Service Manual, 006-01202-0000

This update includes information about:

EPI Series radios

Flex-Mode boards - Systems, 2W RX/TX, 5W RX/TX

New revision (non Flex-Mode) 5W RX/TX board

UCOM (Universal Communications Options Module) board

Insert the attached pages into the EPH Series Service Manual as follows:

1. Remove pages 1-1 to 1-4 and insert the enclosed pages 1-1 to 1-4.
2. Insert pages 6-18 A to H in front of page 6-19.
3. Insert pages 6-36 A to H in front of page 6-37.
4. Insert pages 6-42 A to H in front of page 6-43.
5. Insert pages 6-48 A to G in front of page 6-49.
6. Insert pages 6-52 A to I in front of page 6-53.
7. Remove the back cover of the EPH Service Manual and replace it with the enclosed back cover.
8. Insert this page directly behind the front cover.

If you have any technical questions regarding this update, please contact Customer Service at 1-800-733-2633.

SYSTEMS BOARD (FLEX)

200-08822-0000
200-08822-0030
PAGE 4

EPH
EPI

SYMBOL	OLD PART NO.	NEW PART NO.	DESCRIPTION	A	UM	EPH	EPI
R	52	139-04752-0010	4724-4752-113	RES CH 47.5K TW 1%	EA	1.00	1.00
R	53	139-02373-0010	4724-2373-113	RES CH 237K TW 1%	EA	1.00	1.00
R	54	130-05105-0012	4724-0105-223	RES CH 1M TW 2%	EA	1.00	1.00
R	55	130-05104-0013	4724-0104-233	RES CH 100K TW 5%	EA	1.00	1.00
R	56	130-05303-0013	4724-0303-233	RES CH 30K TW 5%	EA	1.00	1.00
R	57	130-05683-0013	4724-0683-233	RES CH 68K TW 5%	EA	1.00	1.00
R	59	130-05104-0013	4724-0104-233	RES CH 100K TW 5%	EA	1.00	1.00
R	60	130-05104-0013	4724-0104-233	RES CH 100K TW 5%	EA	1.00	1.00
R	61	130-05104-0013	4724-0104-233	RES CH 100K TW 5%	EA	1.00	1.00
R	62	130-03322-0010		RES CH 33.2K TW 1%	EA	1.00	1.00
R	63	130-05513-0012	4724-0513-223	RES CH 51K TW 2%	EA	1.00	1.00
R	64	130-05104-0013	4724-0104-233	RES CH 100K TW 5%	EA	1.00	1.00
R	65	130-05104-0013	4724-0104-233	RES CH 100K TW 5%	EA	1.00	1.00
R	66	130-05104-0013	4724-0104-233	RES CH 100K TW 5%	EA	1.00	1.00
R	67	130-05104-0013	4724-0104-233	RES CH 100K TW 5%	EA	1.00	1.00
R	68	130-05104-0013	4724-0104-233	RES CH 100K TW 5%	EA	1.00	1.00
R	69	130-05104-0013	4724-0104-233	RES CH 100K TW 5%	EA	1.00	1.00
R	70	130-05103-0013	4724-0103-233	RES CH 10K TW 5%	EA	1.00	1.00
R	71	130-05104-0013	4724-0104-233	RES CH 100K TW 5%	EA	1.00	1.00
R	72	130-05202-0013	4724-0202-233	RES CH 2K TW 5%	EA	1.00	1.00
R	73	130-05471-0013	4724-0471-233	RES CH 470 TW 5%	EA	1.00	1.00
R	74	130-05104-0013	4724-0104-233	RES CH 100K TW 5%	EA	1.00	1.00
R	75	130-05682-0013	4724-0682-233	RES CH 6.8K TW 5%	EA	1.00	1.00
R	76	130-05103-0013	4724-0103-233	RES CH 10K TW 5%	EA	1.00	1.00
R	77	130-05105-0013	4724-0105-233	RES CH 1 MEG TW 5%	EA	1.00	1.00
R	79	130-05105-0013	4724-0105-233	RES CH 1 MEG TW 5%	EA	1.00	1.00
R	80	130-05823-0013	4724-0823-233	RES CH 82K TW 5%	EA	1.00	1.00
R	81	130-05132-0013	4724-0132-233	RES CH 1.3K TW 5%	EA	1.00	1.00
R	82	130-05105-0013	4724-0105-233	RES CH 1 MEG TW 5%	EA	1.00	1.00
R	83	130-05335-0013	4724-0335-233	RES CH 3.3M TW 5%	EA	1.00	1.00
R	84	130-05203-0013	4724-0203-233	RES CH 20K TW 5%	EA	1.00	1.00
R	85	133-00270-0007	4750-2003-904	RES VA 100K.08W20%	EA	1.00	1.00
R	86	130-05100-0013	4724-0100-233	RES CH 10 TW 5%	EA	1.00	1.00
R	87	130-05105-0013	4724-0105-233	RES CH 1 MEG TW 5%	EA	1.00	1.00
R	88	130-05103-0013	4724-0103-233	RES CH 10K TW 5%	EA	1.00	1.00
R	89	130-05243-0013	4724-0243-233	RES CH 24K TW 5%	EA	1.00	1.00
R	90	130-05103-0013	4724-0103-233	RES CH 10K TW 5%	EA	1.00	1.00
R	92	130-05104-0013	4724-0104-233	RES CH 100K TW 5%	EA	1.00	1.00
R	93	130-05105-0013	4724-0105-233	RES CH 1 MEG TW 5%	EA	1.00	1.00
R	94	130-05335-0013	4724-0335-233	RES CH 3.3M TW 5%	EA	1.00	1.00
R	95	130-05514-0013	4724-0514-233	RES CH 510K TW 5%	EA	1.00	1.00
R	96	130-05104-0013	4724-0104-233	RES CH 100K TW 5%	EA	1.00	1.00
R	97	130-05332-0013	4724-0332-233	RES CH 3.3K TW 5%	EA	1.00	1.00
R	98	130-05104-0013	4724-0104-233	RES CH 100K TW 5%	EA	1.00	1.00
R	100	130-05105-0013	4724-0105-233	RES CH 1 MEG TW 5%	EA	1.00	1.00
R	101	130-05105-0013	4724-0105-233	RES CH 1 MEG TW 5%	EA	1.00	1.00
R	102	130-05103-0013	4724-0103-233	RES CH 10K TW 5%	EA	1.00	1.00
R	103	130-05102-0013	4724-0102-233	RES CH 1K TW 5%	EA	1.00	1.00
R	104	130-05102-0013	4724-0102-233	RES CH 1K TW 5%	EA	1.00	1.00
R	105	130-05102-0013	4724-0102-233	RES CH 1K TW 5%	EA	1.00	1.00
R	106	130-05102-0013	4724-0102-233	RES CH 1K TW 5%	EA	1.00	1.00
R	107	130-05102-0013	4724-0102-233	RES CH 1K TW 5%	EA	1.00	1.00
R	108	130-05102-0013	4724-0102-233	RES CH 1K TW 5%	EA	1.00	1.00
R	113	139-03921-0010	4724-3921-113	RES CH 3.92K TW 1%	EA	1.00	1.00
R	119	130-05104-0013	4724-0104-233	RES CH 100K TW 5%	EA	1.00	1.00
R	120	130-05103-0013	4724-0103-233	RES CH 10K TW 5%	EA	1.00	1.00
R	125	139-06191-0010	4724-6191-113	RES CH 6.19K TW 1%	EA	1.00	1.00
R	126	130-05000-0015	4724-0000-009	RES CH 0 TW	EA	1.00	1.00
REF	1	300-08822-0000	0008-6706-100	SYS BD CONFIG ASSY	RF	X.	X.
REF	2	002-08822-0000	0007-6706-100	SCH SYS BD CONFIG	RF	X.	X.
RN	1	015-00208-0006	4726-2041-606	R/2R NETWORK	EA	1.00	1.00
RN	2	015-00208-0006	4726-2041-606	R/2R NETWORK	EA	1.00	1.00
RT	1	134-01044-0013	5302-2025-813	THRMSTR SURFACE MT	EA	1.00	1.00
T	1	019-03156-0001	1800-2012-701	COIL ADJ	EA	1.00	1.00
Y	1	044-00151-0000	2338-2061-100	XTAL 10.00MHZ QRTZ	EA	1.00	1.00
Y	2	044-00301-0000	2342-2061-200	4.00MHZ CRYSTAL	EA	1.00	1.00

SECTION I GENERAL INFORMATION

1.1 INTRODUCTION

This manual contains information concerning the physical, mechanical, and electrical characteristics of the BENDIX/KING EPH and EPI Series handheld VHF radios.

1.2 INTRINSICALLY SAFE MODELS

Radios certified Intrinsically Safe for use in hazardous environments require special care in their repair and maintenance. Therefore, it is strongly recommended that you send all Intrinsically Safe radios in need of repair to BENDIX/KING to ensure compliance with Intrinsically Safe certification.

<p style="text-align: center;">WARNING</p> <p style="text-align: center;">MODIFICATION OR IMPROPER REPAIR OF INTRINSICALLY SAFE RADIOS WILL MAKE THEM UNSAFE FOR OPERATION IN HAZARDOUS ENVIRONMENTS AND WILL VOID THEIR INTRINSICALLY SAFE RATING.</p>

1.3 DESCRIPTION

The EPH Series radios are self-contained VHF FM Transceivers covering the frequency range of 148 MHz to 174 MHz (EPI covers 136 to 160 MHz). The units are multi-channel, digitally synthesized radios using a single crystal for frequency control. All models incorporate an EEPROM for the storage of channel frequency, Code Guard™, and Dual Tone Multiple Frequency/Automatic Numeric Identifier (DTMF/ANI) encode information. All models also include low battery and busy channel indicators. Toggle switches control hi/low transmit power, priority scan, and multi-channel scan. Status and channel information is displayed over a liquid crystal display on keyboard/display models. Connectors are provided on the side of the unit for external antenna, microphone, speaker, and other optional accessories. A variety of twist-off battery packs are also available.

A partial list of available features include:

- Frequency range 148 - 174 MHz (EPH) or 136 - 160 MHz (EPI)
- Channel Spacing 25/30 KHz or 12.5/15 KHz
- Transmitter RF output 1.5 Watts or 5/2 Watts
- Metal or Lexan case
- Numeric or Alphanumeric display
- 14 Channels, or 210 Channels in groups of 14

NOTE: 210-channel radios may have special programming features that reduce the number of channels available to the user.

2 WATT RX/TX BOARD (FLEX)

800-08806-0000
PAGE 2

EPH, EPI

SYMBOL	OLD PART NO.	NEW PART NO.	DESCRIPTION	A	UM	QTY
C	78	108-08103-0048	1853-8237-784	CAP CH 10K X7R/50V	EA	1.00
C	79	108-08878-0047	1853-8237-908	CAPCH2700PFX7R/50V	EA	1.00
C	80	108-04104-0047	1853-8237-780	CH 100KX7R/50V	EA	1.00
C	81	108-08103-0047	1853-8237-733	CAP CH 1K X7R/50V	EA	1.00
C	87	098-01188-0082	1852-8483-121	CAP 1.0UF 16V 50%	EA	1.00
C	88	108-00078-0004	1853-8313-883	CAP CH4.7PFNPO/50V	EA	1.00
C	88	108-08103-0047	1853-8237-733	CAP CH 1K X7R/50V	EA	1.00
C	90	108-08103-0048	1853-8237-794	CAP CH 10K X7R/50V	EA	1.00
C	91	108-08103-0047	1853-8237-733	CAP CH 1K X7R/50V	EA	1.00
C	92	108-08103-0047	1853-8237-733	CAP CH 1K X7R/50V	EA	1.00
C	93	108-08103-0048	1853-8237-794	CAP CH 10K X7R/50V	EA	1.00
C	95	108-08103-0047	1853-8237-733	CAP CH 1K X7R/50V	EA	1.00
C	96	108-08103-0048	1853-8237-784	CAP CH 10K X7R/50V	EA	1.00
C	97	108-08103-0048	1853-8237-794	CAP CH 10K X7R/50V	EA	1.00
C	98	108-00078-0010	1853-8325-341	CAP CERAMIC CH	EA	1.00
C	98	108-00078-0010	1853-8325-341	CAP CERAMIC CH	EA	1.00
C	100	108-00078-0010	1853-8325-341	CAP CERAMIC CH	EA	1.00
C	101	108-00078-0010	1853-8325-341	CAP CERAMIC CH	EA	1.00
C	102	108-08103-0018	1853-8313-882	CAP CR 1K NPO/50V	EA	1.00
CR	1	007-08418-0000	4824-2047-300	PIN DIODE	EA	1.00
CR	2	007-04134-0000	4809-2047-100	VARIABLE SET OF 4	EA	1.00
CR	6	007-08188-0000	4824-2008-800	DIO HOT CARRIER	EA	1.00
CR	7	007-08188-0000	4824-2008-800	DIO HOT CARRIER	EA	1.00
CR	8	007-08188-0000	4824-2008-800	DIO HOT CARRIER	EA	1.00
CR	9	007-08188-0000	4824-2008-800	DIO HOT CARRIER	EA	1.00
CR	13	007-08418-0000	4824-2047-300	PIN DIODE	EA	1.00
CR	14	007-08228-0001	4824-2021-800	SOT23 DIO MMBD362	EA	1.00
FL	1	017-00098-0000	2706-2022-900	XTAL FLTR 16.9MHZ	EA	1.00
FL	2	017-00108-0000	2700-2011-200	FLTR CR 488KHZ	EA	1.00
FL	3	017-00137-0000	2701-2047-800	DISCRIMINATOR CER.	EA	1.00
FL	4	017-00143-0000	2706-2022-900	XTAL FLTR, 16.9MHZ	EA	1.00
FL	5	017-00144-0000	2700-2022-900	CER FILTER, 488KHZ	EA	1.00
I	1	120-04088-0003	3134-2048-900	IC ANA/DIG SW	A EA	1.00
I	2	120-03183-0000	3134-2005-800	IC FM/F MC3367D	A EA	1.00
I	3	120-03473-0000	3134-2082-200	OP AMP	A EA	1.00
ITM	1	008-08808-0000	1700-5705-900	PCBD 2W30/12.5 R/T	A EA	1.00
ITM	2	016-01004-0000	1802-0000-001	COMPOUND THRML JNT	AR	1.00
ITM	3	090-00388-0000	8400-2045-900	HEAT SINK TO-6	EA	1.00
ITM	4	081-00320-0000	3105-2001-200	INSUL TO-6	EA	1.00
ITM	8	016-01124-0002	1801-2000-903	FOAM TAPE .38W	IN	0.35
ITM	9	016-01124-0002	1801-2000-903	FOAM TAPE .38W	IN	0.35
ITM	10	016-01124-0002	1801-2000-903	FOAM TAPE .38W	IN	0.50
ITM	11	047-06735-0001	2508-2001-801	CAN DUAL COIL	EA	2.00
ITM	12	047-10487-0001	2508-2029-701	SHIELD 30/12.5 FT	EA	1.00
ITM	13	081-00623-0000	3110-2019-400	INSULATOR XTAL	EA	2.00
ITM	14	047-04977-0002	2540-4000-202	FNGR STOCK .500	EA	1.00
ITM	15	026-00027-0000	6018-0000-001	WIRE CU 18AWG TIN	IN	0.37
J	1	030-01388-0001	2105-2017-401	SCKT MINATURE SPRG	EA	3.00
J	2	030-01388-0001	2105-2017-401	SCKT MINATURE SPRG	EA	10.00
J	3	030-00417-0000	2105-2017-300	20 DGR CONN RCPTBL	EA	1.00
L	1	019-02660-0048	1808-2013-648	INDUCT SURF MT	EA	1.00
L	2	019-02701-0001	1800-2048-101	MOLDED INDUCT	EA	1.00
L	3	019-02701-0002	1800-2048-102	MOLDED INDUCTOR	EA	1.00
L	4	019-02701-0002	1800-2048-102	MOLDED INDUCTOR	EA	1.00
L	5	019-02701-0000	1800-2048-100	MOLDED INDUCTOR	EA	1.00
L	7	019-02660-0048	1808-2013-648	INDUCT SURF MT	EA	1.00
L	8	019-02660-0044	1808-2013-644	INDUCT SURF MT	EA	1.00
L	10	019-02660-0046	1808-2013-646	INDUCT SURFACE MT	EA	1.00
L	12	019-02660-0050	1808-2013-650	INDUCT SURF MT	EA	1.00
L	14	019-02660-0048	1808-2013-648	INDUCT SURFACE MT	EA	1.00
L	15	019-02660-0003	1808-2013-603	INDUCT SURFACE MT	EA	1.00
L	16	019-02660-0047	1808-2013-647	INDUCT SURF MT	EA	1.00
L	18	019-02660-0018	1808-2013-618	INDUCT SURFACE MT	EA	1.00
L	19	019-02660-0043	1808-2013-643	INDUCT SURFACE MT	EA	1.00
L	21	019-02660-0030	1808-2013-630	IND SM 1.5 10%	EA	1.00
L	24	019-02714-0000	1801-2093-000	COIL AIR WOUND	EA	1.00
L	25	019-02717-7205	1801-2023-301	6T .072 24 AWG	EA	1.00

TRANSMITTER

	<u>25/30 KHz</u>	<u>12.5/15 KHz</u>
RF OUTPUT - EPH 21:	1.5 W	1.5 W
RF OUTPUT - EPH 51 (Hi/Lo):	5/2 W	5/2 W
OPERATING FREQUENCY SPREAD	26 MHz	26 MHz
SPURIOUS AND HARMONICS:	60 dB	60 dB
FM HUM AND NOISE (per EIA):	43 dB	37 dB
AUDIO DISTORTION:	3%	3%
AUDIO RESPONSE:	+1 to -3 dB	+1 to -3 dB
MODULATION CHARACTERISTICS:	15KOF2D 16KOF3E 16KOFXE	

RECEIVER

	<u>25/30 KHz</u>	<u>12.5/15 KHz</u>
SENSITIVITY: 12dB SINAD	0.25 μ V	0.25 μ V
OPERATING FREQUENCY SPREAD	26 MHz	26 MHz
SELECTIVITY:	72 dB	60 dB
SPURIOUS, INCLUDING IMAGE:	75 dB	75 dB
INTERMODULATION:	70 dB	60 dB
AUDIO OUTPUT AT 5% DISTORTION:	500 mW	500 mW
AUDIO RESPONSE (PER EIA):	+1dB to -3 dB	+1dB to -3 dB

1.5 ACCESSORIES

A wide variety of optional accessories are available for the EPH hand held transceivers. Contact your BENDIX/KING dealer for complete information.

1.6 LICENSE REQUIREMENTS

This equipment must be licensed by the Federal Communications Commission (FCC) before it may be used. Your BENDIX/KING dealer can assist you in filing the appropriate application for the FCC, and will program each radio with your authorized frequencies and signaling codes.

1.7 SERVICE INFORMATION

If you need service, contact your BENDIX/KING dealer or any BENDIX/KING Mobile Communications dealer equipped to service your radio.

If you find it inconvenient to have service performed by your local dealer, you may contact BENDIX/KING at this address:

BK Radio, Inc.
2901 Lakeview Road, Suite 100
Lawrence, Kansas 66049
(913) 842-0402

2 WATT RX/TX BOARD (FLEX)

200-08806-0000
PAGE 4

EPH, EPI

SYMBOL	OLD PART NO.	NEW PART NO.	DESCRIPTION	A	UM	QTY
R	50	130-05681-0013	4724-0681-233	RES CH 680 TW 5%	EA	1.00
R	52	130-05621-0033	4728-0621-335	RES CHIP 620 QW	EA	1.00
R	53	130-05334-0013	4724-0334-233	RES CH 330K TW 5%	EA	1.00
R	54	130-05102-0013	4724-0102-233	RES CH 1K TW 5%	EA	1.00
R	56	130-05103-0023	4718-5237-310	RES CH 10K EW 5%	EA	1.00
R	57	130-05104-0013	4724-0104-233	RES CH 100K TW 5%	EA	1.00
R	58	130-05104-0013	4724-0104-233	RES CH 100K TW 5%	EA	1.00
R	59	130-05104-0013	4724-0104-233	RES CH 100K TW 5%	EA	1.00
R	60	130-05103-0013	4724-0103-233	RES CH 10K TW 5%	EA	1.00
R	61	130-05300-0023	4718-5398-907	RES CH 30 EW 5%	EA	1.00
R	63	130-05271-0023	4718-5237-317	RES CHIP 270EW5%	EA	1.00
R	64	130-05184-0013	4724-0184-233	RES CH 180K TW 5%	EA	1.00
R	65	130-05301-0023	4718-5317-147	RES CHIP 300 EW 5%	EA	1.00
R	66	130-05201-0023	4718-5317-145	RES CHIP 200EW5%	EA	1.00
R	90	130-05104-0013	4724-0104-233	RES CH 100K TW 5%	EA	1.00
R	91	130-05104-0013	4724-0104-233	RES CH 100K TW 5%	EA	1.00
R	92	130-05104-0013	4724-0104-233	RES CH 100K TW 5%	EA	1.00
R	93	130-05104-0013	4724-0104-233	RES CH 100K TW 5%	EA	1.00
R	94	130-05104-0013	4724-0104-233	RES CH 100K TW 5%	EA	1.00
R	95	130-05104-0013	4724-0104-233	RES CH 100K TW 5%	EA	1.00
R	96	130-05104-0013	4724-0104-233	RES CH 100K TW 5%	EA	1.00
R	97	130-05104-0013	4724-0104-233	RES CH 100K TW 5%	EA	1.00
R	98	130-05104-0013	4724-0104-233	RES CH 100K TW 5%	EA	1.00
R	99	130-05301-0013	4724-0301-233	RES CHIP 300 TW 5%	EA	1.00
R	100	130-05473-0023	4718-5237-324	RES CHIP 47KEW5%	EA	1.00
R	101	130-05104-0013	4724-0104-233	RES CH 100K TW 5%	EA	1.00
R	103	130-05101-0023	4718-5237-313	RES CH 100 EW 5%	EA	1.00
R	104	130-05273-0013	4724-0273-233	RES CH 27K TW 5%	EA	1.00
R	105	130-05222-0013	4724-0222-233	RES CH 2.2K TW 5%	EA	1.00
REF	1	002-08806-0000	0007-5705-900	SCH 2W 30/12.5 R/T	RF	X
REF	2	300-08806-0000	0008-5705-900	2W 30/12.5 R/T ASY	RF	X
T	1	019-08135-0000	1800-2013-200	XFMR MIXER	A EA	1.00
T	2	019-08134-0000	1800-2048-300	XFMR IF T	A EA	1.00
T	3	019-08133-0000	1800-2048-200	XFMR IF	A EA	1.00
Y	1	044-00152-0000	2301-2011-600	XTAL 17.355MHZ	EA	1.00

SYSTEMS BOARD (FLEX)

200-08822-0000
200-08822-0030

EPH
EPI

SYMBOL	OLD PART NO.	NEW PART NO.	DESCRIPTION	A	UM	EPH	EPI
B	1	013-00173-0000	FERRITE BEAD	EA		1.00	1.00
B	2	013-00173-0000	FERRITE BEAD	EA		1.00	1.00
C	1	096-01186-0062	CAP 1.0UF 16V 20%	EA		1.00	1.00
C	2	106-05101-0016	CAP CH100PFNPO/50V	EA		1.00	1.00
C	3	106-05222-0046	CAP CH 2.2KX7R/50V	EA		1.00	1.00
C	4	106-05222-0046	CAP CH 2.2KX7R/50V	EA		1.00	1.00
C	5	106-05560-0016	CAP CH 56PFNPO/50V	EA		1.00	1.00
C	6	102-00054-0001	CAP CERAMIC TRIM	EA		1.00	1.00
C	8	106-05221-0048	CAP CH 220X7R/50V	EA		1.00	1.00
C	9	106-04104-0047	CH 100KX7R/50V	EA		1.00	1.00
C	10	106-04104-0047	CH 100KX7R/50V	EA		1.00	1.00
C	11	106-05221-0048	CAP CH 220X7R/50V	EA		1.00	1.00
C	12	106-05102-0016	CAP CH 1K NPO/50V	EA		1.00	1.00
C	13	106-00072-0006	CAP CH5.6PFNPO/50V	EA		1.00	1.00
C	14	106-05102-0047	CAP CH 1K X7R/50V	EA		1.00	1.00
C	15	106-00072-0008	CAP CH6.8PFNPO/50V	EA		1.00	1.00
C	16	106-00072-0069	CAP CH2.4PFNPO 50V	EA		1.00	1.00
C	17	106-05102-0016	CAP CH 1K NPO/50V	EA		1.00	1.00
C	18	106-05102-0047	CAP CH 1K X7R/50V	EA		1.00	1.00
C	19	096-01186-0062	CAP 1.0UF 16V 20%	EA		1.00	1.00
C	20	106-00120-0000	CAP CHIP SPECIAL	EA		1.00	1.00
C	21	108-05087-0327	CAP PC 0.18UF 50V	EA		1.00	1.00
C	22	106-00072-0012	CAP CH10PF NPO/50V	EA		1.00	1.00
C	23	106-00072-0046	CAP CH 1PF NPO/50V	EA		1.00	1.00
C	24	106-05102-0016	CAP CH 1K NPO/50V	EA		1.00	1.00
C	25	106-05102-0016	CAP CH 1K NPO/50V	EA		1.00	1.00
C	26	106-00072-0044	CAP CH 1.5PF	EA		1.00	1.00
C	27	106-05102-0016	CAP CH 1K NPO/50V	EA		1.00	1.00
C	28	106-05102-0016	CAP CH 1K NPO/50V	EA		1.00	1.00
C	29	106-00072-0034	CAP CH 56PFNPO/50V	EA		1.00	1.00
C	30	106-05682-0046	CAP CH 6.8KX7R/50V	EA		1.00	1.00
C	31	106-00072-0046	CAP CH 1PF NPO/50V	EA		1.00	1.00
C	32	106-05221-0048	CAP CH 220X7R/50V	EA		1.00	1.00
C	33	096-01186-0067	CAP 2.2UF 20V 20%	EA		1.00	1.00
C	34	106-05102-0016	CAP CH 1K NPO/50V	EA		1.00	1.00
C	35	106-05221-0048	CAP CH 220X7R/50V	EA		1.00	1.00
C	36	106-04473-0047	CAP CH 47K X7R/50V	EA		1.00	1.00
C	37	106-05182-0047	CAPCH1800PFX7R/50V	EA		1.00	1.00
C	38	097-00213-0077	CAP AL 220.UF 16V	EA		1.00	1.00
C	39	106-04104-0047	CH 100KX7R/50V	EA		1.00	1.00
C	40	106-04104-0047	CH 100KX7R/50V	EA		1.00	1.00
C	41	106-04104-0047	CH 100KX7R/50V	EA		1.00	1.00
C	42	106-04471-0026	CH 470PF NPO/100V	EA		1.00	1.00
C	43	096-01186-0062	CAP 1.0UF 16V 20%	EA		1.00	1.00
C	44	106-00072-0034	CAP CH 56PFNPO/50V	EA		1.00	1.00
C	45	106-00072-0034	CAP CH 56PFNPO/50V	EA		1.00	1.00
C	46	096-01186-0062	CAP 1.0UF 16V 20%	EA		1.00	1.00
C	47	106-04104-0047	CH 100KX7R/50V	EA		1.00	1.00
C	48	106-05102-0047	CAP CH 1K X7R/50V	EA		1.00	1.00
C	49	096-01186-0064	CAP 10UF 16V 20%	EA		1.00	1.00
C	50	106-05102-0047	CAP CH 1K X7R/50V	EA		1.00	1.00
C	51	106-05101-0016	CAP CH100PFNPO/50V	EA		1.00	1.00
C	52	106-04222-0016	CAPCH2200PFNPO/50V	EA		1.00	1.00
C	53	096-01186-0053	CAP 2.2 UF 6V 20%	EA		1.00	1.00
C	54	106-05102-0047	CAP CH 1K X7R/50V	EA		1.00	1.00
C	55	106-05221-0048	CAP CH 220X7R/50V	EA		1.00	1.00
C	56	106-05102-0016	CAP CH 1K NPO/50V	EA		1.00	1.00
C	57	106-05102-0016	CAP CH 1K NPO/50V	EA		1.00	1.00
C	58	096-01186-0062	CAP 1.0UF 16V 20%	EA		1.00	1.00
C	59	106-05102-0047	CAP CH 1K X7R/50V	EA		1.00	1.00
C	60	106-05102-0016	CAP CH 1K NPO/50V	EA		1.00	1.00
C	61	106-04104-0047	CH 100KX7R/50V	EA		1.00	1.00
C	62	106-05102-0047	CAP CH 1K X7R/50V	EA		1.00	1.00
C	63	096-01186-0062	CAP 1.0UF 16V 20%	EA		1.00	1.00
C	65	106-05102-0016	CAP CH 1K NPO/50V	EA		1.00	1.00

5 WATT RX/TX BOARD (NEW REVISION)

200-08293-0000
200-08293-0030
PAGE 2

EPH
EPI

SYMBOL	OLD PART NO.	NEW PART NO.	DESCRIPTION	A	UM	EPH	EPI
C	49	106-00072-0024	1553-5237-762	CAP CH 22PFNPO/50V	EA	.	1.00
C	50	096-01186-0062	1552-6463-121	CAP 1.0UF 16V 20%	EA	1.00	1.00
C	51	106-05102-0047	1553-5237-733	CAP CH 1K X7R/50V	EA	1.00	1.00
C	52	106-00072-0032	1553-5237-769	CAP CH 47PFNPO/50V	EA	1.00	.
C	52	106-00072-0034	1553-5237-767	CAP CH 56PFNPO/50V	EA	.	1.00
C	53	106-00072-0036	1553-5237-789	CAP CH 68PFNPO/50V	EA	1.00	1.00
C	54	106-05102-0047	1553-5237-733	CAP CH 1K X7R/50V	EA	1.00	1.00
C	55	106-04104-0047	1553-5237-780	CH 100KX7R/50V	EA	1.00	1.00
C	56	106-05102-0047	1553-5237-733	CAP CH 1K X7R/50V	EA	1.00	1.00
C	57	106-00072-0032	1553-5237-769	CAP CH 47PFNPO/50V	EA	1.00	.
C	57	106-00072-0034	1553-5237-767	CAP CH 56PFNPO/50V	EA	.	1.00
C	58	106-00072-0036	1553-5237-789	CAP CH 68PFNPO/50V	EA	1.00	.
C	58	106-00072-0038	1553-5237-783	CAP CH 82PFNPO/50V	EA	.	1.00
C	59	106-00072-0036	1553-5237-789	CAP CH 68PFNPO/50V	EA	1.00	.
C	59	106-00072-0038	1553-5237-783	CAP CH 82PFNPO/50V	EA	.	1.00
C	60	106-05102-0047	1553-5237-733	CAP CH 1K X7R/50V	EA	1.00	1.00
C	61	106-04104-0047	1553-5237-780	CH 100KX7R/50V	EA	1.00	1.00
C	62	106-00072-0032	1553-5237-769	CAP CH 47PFNPO/50V	EA	1.00	1.00
C	63	106-00072-0024	1553-5237-762	CAP CH 22PFNPO/50V	EA	1.00	.
C	63	106-00072-0026	1553-5237-763	CAP CH 27PFNPO/50V	EA	.	1.00
C	64	106-00072-0032	1553-5237-769	CAP CH 47PFNPO/50V	EA	1.00	.
C	64	106-00072-0034	1553-5237-767	CAP CH 56PFNPO/50V	EA	.	1.00
C	65	106-00072-0032	1553-5237-769	CAP CH 47PFNPO/50V	EA	1.00	.
C	65	106-00072-0036	1553-5237-789	CAP CH 68PFNPO/50V	EA	.	1.00
C	66	106-00072-0024	1553-5237-762	CAP CH 22PFNPO/50V	EA	1.00	.
C	66	106-00072-0026	1553-5237-763	CAP CH 27PFNPO/50V	EA	.	1.00
C	67	106-00072-0012	1553-5313-552	CAP CH10PF NPO/50V	EA	.	1.00
C	67	106-00072-0060	1553-5313-517	CAP CR CH 7.5PF	EA	1.00	.
C	68	106-00072-0059	1553-5313-522	CAP CH6.2PFNPO/50V	EA	1.00	1.00
C	69	106-00072-0014	1553-5237-779	CAP CH12PFNPO/50V	EA	1.00	.
C	69	106-00072-0073	1553-5237-773	CAP CH 24PFNPO/50V	EA	.	1.00
C	70	106-00072-0058	1553-5525-314	CAP CR CH 5.1PF	EA	1.00	.
C	70	106-00072-0059	1553-5313-522	CAP CH6.2PFNPO/50V	EA	.	1.00
C	71	106-00072-0014	1553-5237-779	CAP CH12PFNPO/50V	EA	1.00	.
C	71	106-00072-0073	1553-5237-773	CAP CH 24PFNPO/50V	EA	.	1.00
C	72	106-00072-0000	1553-5525-315	CAPCH1.80FNPO/500V	EA	1.00	1.00
C	73	106-00072-0010	1553-5313-551	CAP CH8.2PFNPO/50V	EA	.	1.00
C	73	106-00072-0012	1553-5313-552	CAP CH10PF NPO/50V	EA	1.00	.
C	74	106-00072-0034	1553-5237-767	CAP CH 56PFNPO/50V	EA	1.00	.
C	74	106-00072-0038	1553-5237-783	CAP CH 82PFNPO/50V	EA	.	1.00
C	75	106-05102-0016	1553-5313-582	CAP CH 1K NPO/50V	EA	1.00	1.00
C	76	106-05102-0047	1553-5237-733	CAP CH 1K X7R/50V	EA	1.00	1.00
C	77	096-01186-0064	1552-6463-113	CAP 10UF 16V 20%	EA	1.00	1.00
C	78	106-05103-0048	1553-5237-794	CAP CH 10K X7R/50V	EA	1.00	1.00
C	79	106-04272-0048	1553-5313-574	CAP CH 2.7KX7R/50V	EA	1.00	1.00
C	80	106-04104-0047	1553-5237-780	CH 100KX7R/50V	EA	1.00	1.00
C	81	106-05102-0047	1553-5237-733	CAP CH 1K X7R/50V	EA	1.00	1.00
C	87	096-01186-0062	1552-6463-121	CAP 1.0UF 16V 20%	EA	1.00	1.00
C	88	106-00072-0004	1553-5313-523	CAP CH4.7PFNPO/50V	EA	1.00	1.00
C	89	106-00072-0068	1553-5237-751	CAP CH0.5PFNPO/50V	EA	1.00	1.00
C	90	106-04104-0047	1553-5237-780	CH 100KX7R/50V	EA	1.00	1.00
C	91	106-00072-0012	1553-5313-552	CAP CH10PF NPO/50V	EA	1.00	1.00
C	92	106-05102-0047	1553-5237-733	CAP CH 1K X7R/50V	EA	1.00	1.00
C	93	106-05102-0047	1553-5237-733	CAP CH 1K X7R/50V	EA	1.00	1.00
C	107	106-00072-0012	1553-5313-552	CAP CH 10PF NPO/50V	EA	1.00	.
C	108	106-00072-0014	1553-5237-779	CAP CH 12PFNPO/50V	EA	1.00	.
CR	1	007-06418-0000	4824-2047-300	PIN DIODE	EA	1.00	1.00

SYSTEMS BOARD (FLEX)

200-08822-0000
200-08822-0030
PAGE 3

EPH
EPI

SYMBOL	OLD PART NO.	NEW PART NO.	DESCRIPTION	A	UM	EPH	EPI
Q	7	007-08064-0014	4823-2010-814	XSTR PNP 4.7K, 10K	EA	1.00	1.00
Q	8	007-00065-0001	4823-3669-001	XSTR 2N3906 (SOT)	EA	1.00	1.00
Q	9	007-08064-0015	4823-2010-815	TSTR DIGITAL SO	EA	1.00	1.00
Q	10	007-00065-0001	4823-3669-001	XSTR 2N3906 (SOT)	EA	1.00	1.00
Q	11	007-08064-0017	4823-2010-817	XSTR NPN 47K, 47K	EA	1.00	1.00
Q	12	007-08064-0014	4823-2010-814	XSTR PNP 4.7K, 10K	EA	1.00	1.00
Q	14	007-00065-0001	4823-3669-001	XSTR 2N3906 (SOT)	EA	1.00	1.00
Q	15	007-08064-0005	4823-2010-805	TSTR DIGITAL SO	EA	1.00	1.00
Q	16	007-08064-0017	4823-2010-817	XSTR NPN 47K, 47K	EA	1.00	1.00
Q	17	007-08064-0016	4823-3680-006	XSTR PNP 47K, 47K	EA	1.00	1.00
Q	18	007-08064-0000	4823-2010-800	XSTR PNP 10K, 10K	EA	1.00	1.00
Q	19	007-08064-0015	4823-2010-815	TSTR DIGITAL SO	EA	1.00	1.00
Q	20	007-08064-0017	4823-2010-817	XSTR NPN 47K, 47K	EA	1.00	1.00
Q	21	007-00815-0000	4823-5483-200	XSTR FET MMBFU310	EA	1.00	1.00
Q	22	007-00535-0001	4823-2020-200	XSTR JFET MMBF4392	EA	1.00	1.00
Q	24	007-08064-0017	4823-2010-817	XSTR NPN 47K, 47K	EA	1.00	1.00
Q	25	007-00903-0000	4823-2025-100	2N7002 MOSFET	EA	1.00	
Q	26	007-00903-0000	4823-2025-100	2N7002 MOSFET	EA	1.00	
Q	27	007-08064-0017	4823-2010-817	XSTR NPN 47K, 47K	EA	1.00	1.00
Q	28	007-08064-0014	4823-2010-814	XSTR PNP 4.7K, 10K	EA	1.00	1.00
R	1	130-05105-0013	4724-0105-233	RES CH 1 MEG TW 5%	EA	1.00	1.00
R	2	130-05105-0013	4724-0105-233	RES CH 1 MEG TW 5%	EA	1.00	1.00
R	3	133-00271-0018	4719-2046-218	RES VA 100K 20%	EA	1.00	1.00
R	4	130-05274-0013	4724-0274-233	RES CH 270K TW 5%	EA	1.00	1.00
R	5	130-05823-0013	4724-0823-233	RES CH 82K TW 5%	EA	1.00	1.00
R	7	130-05244-0013	4724-0244-233	RES CH 240K TW 5%	EA	1.00	1.00
R	8	130-05333-0013	4724-0333-233	RES CH 33K TW 5%	EA	1.00	1.00
R	9	130-05104-0013	4724-0104-233	RES CH 100K TW 5%	EA	1.00	1.00
R	10	130-05333-0013	4724-0333-233	RES CH 33K TW 5%	EA	1.00	1.00
R	11	130-05332-0013	4724-0332-233	RES CH 3.3K TW 5%	EA	1.00	1.00
R	12	130-05100-0013	4724-0100-233	RES CH 10 TW 5%	EA	1.00	1.00
R	13	130-05472-0013	4724-0472-233	RES CH 4.7K TW 5%	EA	1.00	1.00
R	14	130-05104-0013	4724-0104-233	RES CH 100K TW 5%	EA	1.00	1.00
R	15	131-05623-0003	4720-0623-134	RES CF 62K TW 5%	EA	1.00	1.00
R	16	131-05104-0003	4720-0104-134	RES CF 100K TW 5%	EA	1.00	1.00
R	17	131-05273-0003	4720-0273-234	RES CF 27K TW 5%	EA	1.00	1.00
R	18	131-05104-0003	4720-0104-134	RES CF 100K TW 5%	EA	1.00	1.00
R	19	131-05273-0003	4720-0273-234	RES CF 27K TW 5%	EA	1.00	1.00
R	20	130-05682-0013	4724-0682-233	RES CH 6.8K TW 5%	EA	1.00	1.00
R	21	130-05102-0013	4724-0102-233	RES CH 1K TW 5%	EA	1.00	1.00
R	22	130-05102-0013	4724-0102-233	RES CH 1K TW 5%	EA	1.00	1.00
R	23	130-05753-0013	4724-0753-233	RES CH 75K TW 5%	EA	1.00	1.00
R	24	130-05473-0013	4724-0473-233	RES CH 47K TW 5%	EA	1.00	1.00
R	25	130-05335-0013	4724-0335-233	RES CH 3.3M TW 5%	EA	1.00	1.00
R	26	130-05164-0013	4724-0164-233	RES CH 160K TW 5%	EA	1.00	1.00
R	27	130-05913-0013	4724-0913-233	RES CH 91K TW 5%	EA	1.00	1.00
R	28	130-05163-0013	4724-0163-233	RES CH 16K TW 5%	EA	1.00	1.00
R	29	130-05151-0013	4724-0151-233	RES CH 150 TW 5%	EA	1.00	1.00
R	30	130-05101-0013	4724-0101-233	RES CH 100 TW 5%	EA	1.00	1.00
R	31	130-05103-0013	4724-0103-233	RES CH 10K TW 5%	EA	1.00	1.00
R	32	130-05302-0013	4724-0302-233	RES CH 3K TW 5%	EA	1.00	1.00
R	33	130-05112-0013	4724-0112-233	RES CH 1.1K TW 5%	EA	1.00	1.00
R	34	130-05200-0013	4724-0200-233	RES CH 20 TW 5%	EA	1.00	1.00
R	35	130-05101-0013	4724-0101-233	RES CH 100 TW 5%	EA	1.00	1.00
R	36	130-05302-0013	4724-0302-233	RES CH 3K TW 5%	EA	1.00	1.00
R	37	130-05513-0013	4724-0513-233	RES CH 51K TW 5%	EA	1.00	1.00
R	38	130-05363-0013	4724-0363-233	RES CH 36K TW 5%	EA	1.00	1.00
R	39	130-05153-0013	4724-0153-233	RES CH 15K TW 5%	EA	1.00	1.00
R	40	133-00272-0005	4719-2046-005	RES VARI	EA	1.00	1.00
R	41	139-02212-0010	4724-2212-113	RES CH 22.1K TW 1%	EA	1.00	1.00
R	42	130-05134-0013	4724-0134-233	RES CH 130K TW 5%	EA	1.00	1.00
R	43	130-05623-0013	4724-0623-387	RES CH 62K TW 5%	EA	1.00	1.00
R	44	130-05333-0013	4724-0333-233	RES CH 33K TW 5%	EA	1.00	1.00
R	45	130-05163-0013	4724-0163-233	RES CH 16K TW 5%	EA	1.00	1.00
R	46	130-05103-0013	4724-0103-233	RES CH 10K TW 5%	EA	1.00	1.00
R	47	130-05103-0013	4724-0103-233	RES CH 10K TW 5%	EA	1.00	1.00
R	48	130-05474-0013	4724-0474-233	RES CH 470K TW 5%	EA	1.00	1.00
R	49	130-05105-0013	4724-0105-233	RES CH 1 MEG TW 5%	EA	1.00	1.00
R	50	130-05243-0013	4724-0243-233	RES CH 24K TW 5%	EA	1.00	1.00
R	51	133-00270-0006	4750-2003-903	RES VA 10K.08W20%	EA	1.00	1.00

5 WATT RX/TX BOARD (NEW REVISION)

200-08293-0000
200-08293-0030
PAGE 4EPH
EPI

SYMBOL	OLD PART NO.	NEW PART NO.	DESCRIPTION	A	UM	EPH	EPI
Q	2	007-08064-0017	4823-2010-817	XSTR NPN 47K, 47K	EA	1.00	1.00
Q	3	007-08064-0015	4823-2010-815	TSTR DIGITAL SO	EA	1.00	1.00
Q	4	007-00529-0000	4823-2008-400	XSTR NPN MMBTH24	EA	1.00	1.00
Q	6	007-00187-0002	4823-3741-401	XSTR SOT-23 2N5089	EA	1.00	1.00
Q	7	007-00539-0000	4823-1367-900	XSTR MMBTH10	EA	1.00	1.00
Q	8	007-00907-0000	4823-2008-300	XSTR BFC17	EA	1.00	1.00
Q	9	007-00936-0000	4823-2046-600	PUR MOSFET N-CHNL	EA	1.00	1.00
Q	10	007-00545-0000	4804-2009-000	XSTR RF PWE 2N6255	EA	1.00	1.00
Q	11	007-00538-0000	4804-2008-900	XSTR RF POWER	EA	1.00	1.00
Q	12	007-08064-0014	4823-2010-814	XSTR PNP 4.7K, 10K	EA	1.00	1.00
Q	12	007-00943-0000	4823-2025-300	XSTR RF NPN	EA	1.00	1.00
R	1	130-05334-0013	4724-0334-233	RES CH 330K TW 5%	EA	1.00	1.00
R	2	130-05101-0023	4718-5237-313	RES CH 100 EW 5%	EA	1.00	1.00
R	3	130-05101-0023	4718-5237-313	RES CH 100 EW 5%	EA	1.00	1.00
R	4	130-05124-0013	4724-0124-233	RES CH 120K EW 5%	EA	1.00	1.00
R	5	130-05124-0013	4724-0124-233	RES CH 120K TW 5%	EA	1.00	1.00
R	7	130-05271-0023	4718-5237-317	RES CHIP 270EW5%	EA	1.00	1.00
R	7	130-05511-0023	4718-5317-149	RES CHIP 510 EW 5%	EA	1.00	1.00
R	8	130-05103-0013	4724-0103-233	RES CH 10K TW 5%	EA	1.00	1.00
R	9	130-05221-0023	4718-5237-323	RES CHIP 220 EW 5%	EA	1.00	1.00
R	10	130-05103-0013	4724-0103-233	RES CH 10K TW 5%	EA	1.00	1.00
R	11	130-05124-0023	4718-5237-359	RES CHIP 120KEW5%	EA	1.00	1.00
R	12	130-05124-0023	4718-5237-359	RES CHIP 120KEW5%	EA	1.00	1.00
R	13	130-05103-0023	4718-5237-310	RES CH 10K EW 5%	EA	1.00	1.00
R	14	130-09003-0000	4728-0019-945	RES CH 0.10 10% QS	EA	1.00	1.00
R	19	130-05274-0023	4718-5237-344	RES CHIP 270KEW5%	EA	1.00	1.00
R	20	130-05472-0023	4718-5237-303	RES CHIP 4.7KEW5%	EA	1.00	1.00
R	21	130-05101-0023	4718-5237-313	RES CH 100 EW 5%	EA	1.00	1.00
R	22	130-05753-0013	4724-0753-233	RES CH 75K TW 5%	EA	1.00	1.00
R	23	130-05202-0013	4724-0202-233	RES CH 2K TW 5%	EA	1.00	1.00
R	24	130-05202-0023	4718-5317-151	RES CHIP 2K EW 5%	EA	1.00	1.00
R	25	130-05473-0023	4718-5237-324	RES CHIP 47KEW5%	EA	1.00	1.00
R	26	130-05152-0023	4718-5237-319	RES CHIP 1.5KEW5%	EA	1.00	1.00
R	28	133-00272-0002	4719-2046-002	RES VARI 2K	EA	1.00	1.00
R	29	130-05392-0013	4724-0392-233	RES CH 3.9K TW 5%	EA	1.00	1.00
R	30	130-05471-0013	4724-0471-233	RES CH 470 TW 5%	EA	1.00	1.00
R	31	130-05154-0013	4724-0154-233	RES CH 150K TW 5%	EA	1.00	1.00
R	32	130-05684-0023	4718-5237-334	RES CHIP 680KEW5%	EA	1.00	1.00
R	33	130-05474-0023	4718-5237-336	RES CHIP 470KEW5%	EA	1.00	1.00
R	34	130-05913-0013	4724-0913-233	RES CH 91K TW 5%	EA	1.00	1.00
R	35	130-05204-0023	4718-5237-382	RES CHIP 200KEW5%	EA	1.00	1.00
R	36	130-05682-0023	4718-5237-381	RES CHIP 6.8KEW5%	EA	1.00	1.00
R	37	130-05202-0013	4724-0202-233	RES CH 2K TW 5%	EA	1.00	1.00
R	38	130-05151-0013	4724-0151-233	RES CH 150 TW 5%	EA	1.00	1.00
R	39	130-05101-0013	4724-0101-233	RES CH 100 TW 5%	EA	1.00	1.00
R	40	130-05102-0023	4718-5237-301	RES CH 1K EW 5%	EA	1.00	1.00
R	41	130-05271-0013	4724-0271-233	RES CH 270 TW 5%	EA	1.00	1.00
R	42	130-05100-0023	4718-5237-347	RES CH 10 EW 5%	EA	1.00	1.00
R	43	130-05202-0012	4724-0202-223	RES CH 2K TW 2%	EA	1.00	1.00
R	44	130-05753-0012	4724-0753-223	RES CH 75K TW 2%	EA	1.00	1.00
R	45	130-05753-0012	4724-0753-223	RES CH 75K TW 2%	EA	1.00	1.00
R	46	130-05202-0012	4724-0202-223	RES CH 2K TW 2%	EA	1.00	1.00
R	47	130-05022-0033	4728-0229-335	RES CHIP 2.2QW 5%	EA	1.00	1.00
R	48	130-05022-0033	4728-0229-335	RES CHIP 2.2QW 5%	EA	1.00	1.00
R	49	130-05101-0043	4729-0101-336	RES CHIP 100 HW	EA	1.00	1.00
R	50	130-05030-0033	4728-0030-335	RES CH 3.0 QW 5%	EA	1.00	1.00
R	52	130-05621-0033	4728-0621-335	RES CHIP 620 QW	EA	1.00	1.00
R	53	130-05334-0013	4724-0334-233	RES CH 330K TW 5%	EA	1.00	1.00
R	54	130-05102-0013	4724-0102-233	RES CH 1K TW 5%	EA	1.00	1.00
R	55	130-05220-0023	4718-5398-912	RES CHIP 22 5% EW	EA	1.00	1.00
R	56	130-05103-0023	4718-5237-310	RES CHIP 10K EW 5%	EA	1.00	1.00
R	57	130-05103-0023	4718-5237-310	RES CHIP 10K EW 5%	EA	1.00	1.00
R	58	130-05103-0023	4718-5237-310	RES CHIP 10K EW 5%	EA	1.00	1.00
R	59	130-05511-0023	4718-5317-149	RES CHIP 510 EW 5%	EA	1.00	1.00
R	60	130-05221-0023	4718-5237-323	RES CHIP 220 EW 5%	EA	1.00	1.00
R	61	130-05000-0015	4724-0000-009	RES CHIP 0 TW	EA	1.00	1.00
R	62	130-05000-0015	4724-0000-009	RES CHIP 0 TW	EA	1.00	1.00

2 WATT RX/TX BOARD (FLEX)

200-08806-0000

EPH, EPI

SYMBOL	OLD PART NO.	NEW PART NO.	DESCRIPTION	A	UM	QTY
B	2	013-00173-0000	2502-2022-300	FERRITE BEAD	EA	1.00
B	3	013-00173-0000	2502-2022-300	FERRITE BEAD	EA	1.00
B	4	013-00172-0000	2502-2022-200	FERR BEAD SRFC MT	EA	1.00
B	5	013-00173-0000	2502-2022-300	FERRITE BEAD	EA	1.00
B	6	013-00172-0000	2502-2022-200	FERR BEAD SRFC MT	EA	1.00
B	7	013-00173-0000	2502-2022-300	FERRITE BEAD	EA	1.00
C	1	106-00072-0034	1553-5237-767	CAP CH 56PFNPO/50V	EA	1.00
C	2	106-00072-0058	1553-5525-314	CAP CR CH 5.1PF	EA	1.00
C	3	106-00072-0053	1553-5237-754	CAP CR CH 3.0PF	EA	1.00
C	4	106-05102-0016	1553-5313-582	CAP CH 1K NPO/50V	EA	1.00
C	5	106-00072-0028	1553-5313-520	CAP CH 36PFNPO/50V	EA	1.00
C	6	106-00116-0049	1564-2042-549	CAP CHIP PORCELAIN	EA	1.00
C	7	106-00116-0049	1564-2042-549	CAP CHIP PORCELAIN	EA	1.00
C	8	106-05102-0047	1553-5237-733	CAP CH 1K X7R/50V	EA	1.00
C	9	106-05102-0016	1553-5313-582	CAP CH 1K NPO/50V	EA	1.00
C	10	106-05102-0047	1553-5237-733	CAP CH 1K X7R/50V	EA	1.00
C	11	106-00116-0049	1564-2042-549	CAP CHIP PORCELAIN	EA	1.00
C	12	106-00116-0049	1564-2042-549	CAP CHIP PORCELAIN	EA	1.00
C	13	106-04104-0047	1553-5237-780	CH 100KX7R/50V	EA	1.00
C	14	106-05102-0016	1553-5313-582	CAP CH 1K NPO/50V	EA	1.00
C	15	106-05102-0016	1553-5313-582	CAP CH 1K NPO/50V	EA	1.00
C	16	106-05103-0046	1553-5237-794	CAP CH 10K X7R/50V	EA	1.00
C	17	106-05102-0016	1553-5313-582	CAP CH 1K NPO/50V	EA	1.00
C	18	106-05102-0047	1553-5237-733	CAP CH 1K X7R/50V	EA	1.00
C	19	106-05102-0047	1553-5237-733	CAP CH 1K X7R/50V	EA	1.00
C	20	106-00072-0012	1553-5313-552	CAP CH 10PF NPO/50V	EA	1.00
C	21	106-00072-0031	1553-5525-320	CAP CH 39PFNPO/50V	EA	1.00
C	22	106-00072-0010	1553-5313-551	CAP CH 8.2PFNPO/50V	EA	1.00
C	24	106-05102-0047	1553-5237-733	CAP CH 1K X7R/50V	EA	1.00
C	25	106-05103-0046	1553-5237-794	CAP CH 10K X7R/50V	EA	1.00
C	26	106-05103-0046	1553-5237-794	CAP CH 10K X7R/50V	EA	1.00
C	28	106-05103-0046	1553-5237-794	CAP CH 10K X7R/50V	EA	1.00
C	29	106-05103-0046	1553-5237-794	CAP CH 10K X7R/50V	EA	1.00
C	30	106-05121-0016	1553-5313-503	CAP CH 120PFNPO/50V	EA	1.00
C	31	106-00072-0042	1553-5237-701	CAP CH 33PFNPO/50V	EA	1.00
C	33	106-04473-0048	1553-5237-782	CAP CH 47K X7R/50V	EA	1.00
C	34	106-04473-0048	1553-5237-782	CAP CH 47K X7R/50V	EA	1.00
C	35	106-05121-0016	1553-5313-503	CAP CH 120PFNPO/50V	EA	1.00
C	37	106-05103-0046	1553-5237-794	CAP CH 10K X7R/50V	EA	1.00
C	38	106-05561-0046	1553-5525-317	CH 560PF 7R/50V	EA	1.00
C	39	106-05121-0016	1553-5313-503	CAP CH 120PFNPO/50V	EA	1.00
C	40	106-05560-0016	1553-5237-767	CAP CH 56PFNPO/50V	EA	1.00
C	41	106-05122-0047	1553-5525-318	CAP CH 1200PFX7R/50V	EA	1.00
C	42	106-05222-0046	1553-5525-301	CAP CH 2.2KX7R/50V	EA	1.00
C	43	106-01186-0082		CAP 1.0UF 16V 20%	EA	1.00
C	44	106-00072-0016	1553-5313-504	CAP CH 15PFNPO/50V	EA	1.00
C	45	106-04104-0047	1553-5237-780	CH 100KX7R/50V	EA	1.00
C	46	106-00072-0016	1553-5313-504	CAP CH 15PFNPO/50V	EA	1.00
C	47	106-05102-0047	1553-5237-733	CAP CH 1K X7R/50V	EA	1.00
C	48	106-05102-0047	1553-5237-733	CAP CH 1K X7R/50V	EA	1.00
C	50	096-01186-0062	1552-6463-121	CAP 1.0UF 16V 20%	EA	1.00
C	51	106-05102-0047	1553-5237-733	CAP CH 1K X7R/50V	EA	1.00
C	52	106-00072-0024	1553-5237-762	CAP CH 22PFNPO/50V	EA	1.00
C	53	106-05102-0047	1553-5237-733	CAP CH 1K X7R/50V	EA	1.00
C	54	106-05102-0047	1553-5237-733	CAP CH 1K X7R/50V	EA	1.00
C	56	106-05102-0047	1553-5237-733	CAP CH 1K X7R/50V	EA	1.00
C	57	106-00072-0074	1553-5237-799	CAP CH 30PFNPO/50V	EA	1.00
C	59	106-00072-0036	1553-5237-789	CAP CH 68PFNPO/50V	EA	1.00
C	60	106-05102-0047	1553-5237-733	CAP CH 1K X7R/50V	EA	1.00
C	62	106-05103-0046	1553-5237-794	CAP CH 10K X7R/50V	EA	1.00
C	63	106-05102-0047	1553-5237-733	CAP CH 1K X7R/50V	EA	1.00
C	67	106-00072-0042	1553-5237-701	CAP CH 33PFNPO/50V	EA	1.00
C	68	106-00072-0061	1553-5525-322	CAP CR CH 9.1PF	EA	1.00
C	69	106-00072-0032	1553-5237-769	CAP CH 47PFNPO/50V	EA	1.00
C	70	106-00072-0044	1553-5313-556	CAP CH 1.5PF	EA	1.00
C	71	106-00072-0034	1553-5237-767	CAP CH 56PFNPO/50V	EA	1.00
C	72	106-00072-0010	1553-5313-551	CAP CH 8.2PFNPO/50V	EA	1.00
C	73	106-00072-0020	1553-5237-798	CAP CH 20PFNPO/50V	EA	1.00
C	74	106-00072-0034	1553-5237-767	CAP CH 56PFNPO/50V	EA	1.00
C	75	106-05102-0016	1553-5313-582	CAP CH 1K NPO/50V	EA	1.00
C	76	106-05102-0047	1553-5237-733	CAP CH 1K X7R/50V	EA	1.00
C	77	096-01186-0064	1552-6463-113	CAP 10UF 16V 20%	EA	1.00

5 WATT RX/TX BOARD (FLEX)

200-08830-0000
PAGE 2

EPH

SYMBOL	OLD PART NO.	NEW PART NO.	DESCRIPTION	A	UM	EPH
C	71	106-00072-0014	1553-5237-779	CAP CH12PFNPO/50V	EA	1.00
C	72	106-00072-0000	1553-5525-315	CAPCH1.80FNPO/500V	EA	1.00
C	73	106-00072-0012	1553-5313-552	CAP CH10PF NPO/50V	EA	1.00
C	74	106-00072-0034	1553-5237-767	CAP CH 56PFNPO/50V	EA	1.00
C	75	106-05102-0016	1553-5313-582	CAP CH 1K NPO/50V	EA	1.00
C	76	106-05102-0047	1553-5237-733	CAP CH 1K X7R/50V	EA	1.00
C	77	096-01186-0064	1552-6463-113	CAP 10UF 16V 20%	EA	1.00
C	78	106-05103-0046	1553-5237-794	CAP CH 10K X7R/50V	EA	1.00
C	79	106-05272-0047	1553-5525-302	CAPCH2700PFX7R/50V	EA	1.00
C	80	106-04104-0047	1553-5237-780	CH 100KX7R/50V	EA	1.00
C	81	106-05102-0047	1553-5237-733	CAP CH 1K X7R/50V	EA	1.00
C	82	106-05103-0046	1553-5237-794	CAP CH 10K X7R/50V	EA	1.00
C	83	106-05103-0046	1553-5237-794	CAP CH 10K X7R/50V	EA	1.00
C	87	096-01186-0062	1552-6463-121	CAP 1.0UF 16V 20%	EA	1.00
C	88	106-00072-0004	1553-5313-523	CAP CH4.7PFNPO/50V	EA	1.00
C	89	106-00072-0058	1553-5525-314	CAP CR CH 5.1PF	EA	1.00
C	90	106-05104-0078	1553-5525-316	CAP CH 100KZ5U/50V	EA	1.00
C	91	106-00072-0004	1553-5313-523	CAP CH4.7PFNPO/50V	EA	1.00
C	92	106-05102-0047	1553-5237-733	CAP CH 1K X7R/50V	EA	1.00
C	93	106-05102-0047	1553-5237-733	CAP CH 1K X7R/50V	EA	1.00
C	94	106-05102-0047	1553-5237-733	CAP CH 1K X7R/50V	EA	1.00
C	95	106-05102-0047	1553-5237-733	CAP CH 1K X7R/50V	EA	1.00
C	96	106-05103-0046	1553-5237-794	CAP CH 10K X7R/50V	EA	1.00
C	97	106-05103-0046	1553-5237-794	CAP CH 10K X7R/50V	EA	1.00
C	98	106-05102-0047	1553-5237-733	CAP CH 1K X7R/50V	EA	1.00
C	99	106-05103-0046	1553-5237-794	CAP CH 10K X7R/50V	EA	1.00
C	100	106-05103-0046	1553-5237-794	CAP CH 10K X7R/50V	EA	1.00
C	107	106-00072-0012	1553-5313-552	CAP CH 10PF NPO/50V	EA	1.00
C	108	106-00072-0014	1553-5237-779	CAP CH 12PFNPO/50V	EA	1.00
C	109	106-00078-0010	1553-5525-341	CAP CERAMIC CHIP	EA	1.00
C	110	106-00078-0010	1553-5525-341	CAP CERAMIC CHIP	EA	1.00
C	111	106-00078-0010	1553-5525-341	CAP CERAMIC CHIP	EA	1.00
C	112	106-00078-0010	1553-5525-341	CAP CERAMIC CHIP	EA	1.00
C	113	106-05102-0047	1553-5237-733	CAP CH 1K X7R/50V	EA	1.00
C	114	106-05102-0047	1553-5237-733	CAP CH 1K X7R/50V	EA	1.00
CR	1	007-06418-0000	4824-2047-300	PIN DIODE	EA	1.00
CR	2	007-04134-0000	4809-2047-100	VARACTOR SET OF 4	EA	1.00
CR	6	007-06188-0000	4824-2008-600	DIO HOT CARRIER	EA	1.00
CR	7	007-06188-0000	4824-2008-600	DIO HOT CARRIER	EA	1.00
CR	8	007-06188-0000	4824-2008-600	DIO HOT CARRIER	EA	1.00
CR	9	007-06188-0000	4824-2008-600	DIO HOT CARRIER	EA	1.00
CR	13	007-06418-0000	4824-2047-300	PIN DIODE	EA	1.00
CR	14	007-06226-0001	4824-2021-800	SOT23 DIO MMBD352	EA	1.00
FL	1	017-00096-0000	2705-2022-600	XTAL FLTR 16.9MHZ	EA	1.00
FL	2	017-00106-0000	2700-2011-200	FLTR CR 455KHZ	EA	1.00
FL	3	017-00137-0000	2701-2047-500	DISCRIMINATOR CER.	EA	1.00
FL	4	017-00143-0000	2705-2022-800	XTAL FLTR, 16.9MHZ	EA	1.00
FL	4	017-00144-0000	2700-2022-900	CER FILTER, 455KHZ	EA	1.00
I	1	123-04066-0003	3134-2048-900	IC ANA/DIG SW	EA	1.00
I	2	120-03193-0000	3134-2005-500	IC FM/IF MC3357D	EA	1.00
I	3	120-03473-0000	3134-2082-200	OP AMP	EA	1.00
ITM	1	009-08830-0000	1700-5705-400	PCBD 5W30/12.5 R/T	A EA	1.00
ITM	4	091-00320-0000	3105-2001-200	INSUL TO-5	EA	1.00
ITM	5	076-01455-0001	5400-2027-501	ADAPTOR W/FIN	A EA	1.00
ITM	8	016-01124-0002	1601-2000-903	FOAM TAPE .38W	IN	0.35
ITM	9	016-01124-0002	1601-2000-903	FOAM TAPE .38W	IN	0.35
ITM	10	016-01124-0002	1601-2000-903	FOAM TAPE .38W	IN	0.50
ITM	11	047-06735-0001	2508-2001-601	CAN DUAL COIL	EA	2.00
ITM	12	047-06707-0001	2508-2029-401	GROUND LUG XSTR	EA	1.00
ITM	14	047-04977-0002	2540-4000-202	FNGR STOCK .500	EA	1.00
ITM	15	047-10467-0001	2508-2029-701	SHIELD 30/12.5 RT	EA	1.00
ITM	16	026-00027-0000	6018-0000-001	WIRE CU38AWG TIN	IN	0.18
J	1	030-01386-0001	2108-2017-401	SCKT MINATURE SPRG	EA	3.00
J	2	030-01386-0001	2108-2017-401	SCKT MINATURE SPRG	EA	10.00
J	3	030-00417-0000	2105-2017-300	20 DGR CONN RCPTBL	EA	1.00
L	1	019-02660-0048	1808-2013-648	INDUCT SURF MT	EA	1.00

2 WATT RX/TX BOARD (FLEX)

200-08806-0000
PAGE 3

EPH, EPI

SYMBOL	OLD PART NO.	NEW PART NO.	DESCRIPTION	UM	QTY	
L	26	019-02717-8205	1801-2023-302	5T .082 24 AWG	EA	1.00
Q	1	007-00943-0000	4823-2025-300	XSTR RF NPN	EA	1.00
Q	2	007-08064-0017	4823-2010-817	XSTR NPN 47K, 47K	EA	1.00
Q	3	007-08064-0015	4823-2010-815	TSTR DIGITAL SO	EA	1.00
Q	4	007-00529-0000	4823-2006-400	XSTR NPN MMBTH24	EA	1.00
Q	6	007-00187-0002	4823-3741-401	XSTR SOT-23 2N5089	EA	1.00
Q	7	007-00907-0000	4823-2008-300	XSTR BFQ17	EA	1.00
Q	8	007-00907-0000	4823-2008-300	XSTR BFQ17	EA	1.00
Q	9	007-00936-0000	4823-2046-600	PUR MOSFET N-CHNL	EA	1.00
Q	10	007-00250-0000	4804-2007-700	XSTR 2N4427	EA	1.00
Q	11	007-00418-0000	4804-2094-300	XSTR RF SRF3163	EA	1.00
Q	12	007-08064-0014	4823-2010-814	XSTR PNP 4.7K, 10K	EA	1.00
Q	14	007-00982-0000	4823-2020-600	MSFET TETRODE N-CH	EA	1.00
Q	16	007-00982-0000	4823-2020-600	MSFET TETRODE N-CH	EA	1.00
Q	17	007-00982-0000	4823-2020-600	MSFET TETRODE N-CH	EA	1.00
Q	18	007-00982-0000	4823-2020-600	MSFET TETRODE N-CH	EA	1.00
Q	19	007-00982-0000	4823-2020-600	MSFET TETRODE N-CH	EA	1.00
Q	20	007-00982-0000	4823-2020-600	MSFET TETRODE N-CH	EA	1.00
Q	23	007-08064-0017	4823-2010-817	XSTR NPN 47K, 47K	EA	1.00
Q	24	007-00903-0000	4823-2025-100	2N7002 MOSFET	EA	1.00
Q	25	007-00982-0000	4823-2020-600	MSFET TETRODE N-CH	EA	1.00
Q	26	007-00982-0000	4823-2020-600	MSFET TETRODE N-CH	EA	1.00
R	1	130-05334-0013	4724-0334-233	RES CH 330K TW 5%	EA	1.00
R	2	130-05152-0013	4724-0152-233	RES CH 1.5K TW 5%	EA	1.00
R	3	130-05104-0013	4724-0104-233	RES CH 100K TW 5%	EA	1.00
R	4	130-05124-0013	4724-0124-233	RES CH 120K TW 5%	EA	1.00
R	5	130-05124-0013	4724-0124-233	RES CH 120K TW 5%	EA	1.00
R	6	130-05104-0013	4724-0104-233	RES CH 100K TW 5%	EA	1.00
R	7	130-05511-0023	4718-5317-149	RES CHIP 510 EW 5%	EA	1.00
R	8	130-05103-0013	4724-0103-233	RES CH 10K TW 5%	EA	1.00
R	9	130-05221-0023	4718-5237-323	RES CHIP 220 EW 5%	EA	1.00
R	10	130-05103-0013	4724-0103-233	RES CH 10K TW 5%	EA	1.00
R	11	130-05124-0023	4718-5237-359	RES CHIP 120KEW5%	EA	1.00
R	12	130-05124-0023	4718-5237-359	RES CHIP 120KEW5%	EA	1.00
R	13	130-05103-0023	4718-5237-310	RES CH 10K EW 5%	EA	1.00
R	14	130-09003-0000	4728-0019-945	RES CH 0.10 10% QS	EA	1.00
R	15	130-05104-0013	4724-0104-233	RES CH 100K TW 5%	EA	1.00
R	16	130-05104-0013	4724-0104-233	RES CH 100K TW 5%	EA	1.00
R	17	130-05104-0013	4724-0104-233	RES CH 100K TW 5%	EA	1.00
R	18	130-05104-0013	4724-0104-233	RES CH 100K TW 5%	EA	1.00
R	19	130-05183-0023	4718-5237-378	RES CHIP 18KEW5%	EA	1.00
R	20	130-05472-0013	4724-0472-233	RES CHIP 4.7K TW 5%	EA	1.00
R	21	130-05101-0023	4718-5237-313	RES CH 100 EW 5%	EA	1.00
R	22	130-05753-0013	4724-0753-233	RES CH 75K TW 5%	EA	1.00
R	23	130-05202-0013	4724-0202-233	RES CH 2K TW 5%	EA	1.00
R	24	130-05202-0023	4718-5317-151	RES CHIP 2K EW 5%	EA	1.00
R	25	130-05473-0023	4718-5237-324	RES CHIP 47KEW5%	EA	1.00
R	26	130-05152-0023	4718-5237-319	RES CHIP 1.5KEW5%	EA	1.00
R	28	133-00271-0008	4719-2046-208	RES VAS 2.2K 100V	EA	1.00
R	29	130-05392-0013	4724-0392-233	RES CH 3.9K TW 5%	EA	1.00
R	30	130-05471-0013	4724-0471-233	RES CH 470 TW 5%	EA	1.00
R	31	130-05154-0013	4724-0154-233	RES CH 150K TW 5%	EA	1.00
R	32	130-05684-0023	4718-5237-334	RES CHIP 680KEW5%	EA	1.00
R	33	130-05474-0023	4718-5237-336	RES CHIP 470KEW5%	EA	1.00
R	34	130-05913-0013	4724-0913-233	RES CH 91K TW 5%	EA	1.00
R	35	130-05204-0023	4718-5237-382	RES CHIP 200KEW5%	EA	1.00
R	36	130-05302-0023	4718-5237-332	RES CHIP 3K EW 5%	EA	1.00
R	37	130-05751-0013	4724-0751-233	RES CH 750 TW 5%	EA	1.00
R	38	130-05131-0013	4724-0131-233	RES CH 130 TW 5%	EA	1.00
R	39	130-05101-0013	4724-0101-233	RES CH 100 TW 5%	EA	1.00
R	40	130-05102-0023	4718-5237-301	RES CH 1K EW 5%	EA	1.00
R	41	130-05221-0013	4724-0221-233	RES CH 220 TW 5%	EA	1.00
R	42	130-05100-0023	4718-5237-347	RES CH 10 EW 5%	EA	1.00
R	43	130-05202-0012	4724-0202-223	RES CH 2K TW 2%	EA	1.00
R	44	130-05104-0012	4724-0104-223	RES CH 100K TW 2%	EA	1.00
R	45	130-05104-0012	4724-0104-223	RES CH 100K TW 2%	EA	1.00
R	46	130-05202-0012	4724-0202-223	RES CH 2K TW 2%	EA	1.00
R	47	130-05271-0013	4724-0271-233	RES CH 270 TW 5%	EA	1.00
R	48	130-05271-0013	4724-0271-233	RES CH 270 TW 5%	EA	1.00
R	49	130-05221-0013	4724-0221-233	RES CH 220 TW 5%	EA	1.00

5 WATT RX/TX BOARD (FLEX)

200-08830-0000
PAGE 4

EPH

SYMBOL	OLD PART NO.	NEW PART NO.	DESCRIPTION	A	UM	EPH
R	32	130-05684-0023	4718-5237-334	RES CHIP 680KEW5%	EA	1.00
R	33	130-05474-0023	4718-5237-336	RES CHIP 470KEW5%	EA	1.00
R	34	130-05913-0013	4724-0913-233	RES CH 91K TW 5%	EA	1.00
R	35	130-05204-0023	4718-5237-382	RES CHIP 200KEW5%	EA	1.00
R	36	130-05682-0013	4724-0682-233	RES CHIP 6.8K TW 5%	EA	1.00
R	37	130-05202-0013	4724-0202-233	RES CH 2K TW 5%	EA	1.00
R	38	130-05151-0013	4724-0151-233	RES CH 150 TW 5%	EA	1.00
R	39	130-05101-0013	4724-0101-233	RES CH 100 TW 5%	EA	1.00
R	40	130-05102-0023	4718-5237-301	RES CH 1K EW 5%	EA	1.00
R	41	130-05271-0013	4724-0271-233	RES CH 270 TW 5%	EA	1.00
R	42	130-05100-0023	4718-5237-347	RES CH 10 EW 5%	EA	1.00
R	43	130-05202-0012	4724-0202-223	RES CH 2K TW 2%	EA	1.00
R	44	130-05753-0012	4724-0753-223	RES CH 75K TW 2%	EA	1.00
R	45	130-05753-0012	4724-0753-223	RES CH 75K TW 2%	EA	1.00
R	46	130-05202-0012	4724-0202-223	RES CH 2K TW 2%	EA	1.00
R	47	130-05022-0033	4728-0229-335	RES CHIP 2.2QW 5%	EA	1.00
R	48	130-05022-0033	4728-0229-335	RES CHIP 2.2QW 5%	EA	1.00
R	49	130-05101-0043	4729-0101-336	RES CHIP 100 HW	EA	1.00
R	50	130-05030-0033	4728-0030-335	RES CH 3.0 QW 5%	EA	1.00
R	51	130-05473-0013	4724-0473-233	RES CH 47K TW 5%	EA	1.00
R	52	130-05621-0033	4728-0621-335	RES CHIP 620 QW	EA	1.00
R	53	130-05334-0013	4724-0334-233	RES CH 330K TW 5%	EA	1.00
R	54	130-05102-0013	4724-0102-233	RES CH 1K TW 5%	EA	1.00
R	55	130-05220-0023	4718-5398-912	RES CHIP 22 5% EW	EA	1.00
R	56	130-05103-0023	4718-5237-310	RES CHIP 10K EW 5%	EA	1.00
R	57	130-05103-0013	4724-0103-233	RES CHIP 10K TW 5%	EA	1.00
R	58	130-05103-0013	4724-0103-233	RES CHIP 10K TW 5%	EA	1.00
R	59	130-05511-0013	4724-0511-233	RES CHIP 510 TW 5%	EA	1.00
R	60	130-05221-0013	4724-0221-233	RES CHIP 220 TW 5%	EA	1.00
R	64	130-05184-0013	4724-0184-233	RES CH 180K TW 5%	EA	1.00
R	65	130-05473-0013	4724-0473-233	RES CH 47K TW 5%	EA	1.00
R	66	130-05104-0013	4724-0104-233	RES CH 100K TW 5%	EA	1.00
R	81	130-05104-0013	4724-0104-233	RES CH 100K TW 5%	EA	1.00
R	82	130-05104-0013	4724-0104-233	RES CH 100K TW 5%	EA	1.00
R	83	130-05104-0013	4724-0104-233	RES CH 100K TW 5%	EA	1.00
R	84	130-05104-0013	4724-0104-233	RES CH 100K TW 5%	EA	1.00
R	85	130-05104-0013	4724-0104-233	RES CH 100K TW 5%	EA	1.00
R	86	130-05104-0013	4724-0104-233	RES CH 100K TW 5%	EA	1.00
R	87	130-05104-0013	4724-0104-233	RES CH 100K TW 5%	EA	1.00
R	88	130-05104-0013	4724-0104-233	RES CH 100K TW 5%	EA	1.00
R	89	130-05152-0013	4724-0152-233	RES CH 1.5K TW 5%	EA	1.00
R	90	130-05104-0013	4724-0104-233	RES CH 100K TW 5%	EA	1.00
R	91	130-05104-0013	4724-0104-233	RES CH 100K TW 5%	EA	1.00
R	92	130-05104-0013	4724-0104-233	RES CH 100K TW 5%	EA	1.00
R	93	130-05104-0013	4724-0104-233	RES CH 100K TW 5%	EA	1.00
R	94	130-05104-0013	4724-0104-233	RES CH 100K TW 5%	EA	1.00
R	95	130-05104-0013	4724-0104-233	RES CH 100K TW 5%	EA	1.00
R	96	130-05104-0013	4724-0104-233	RES CH 100K TW 5%	EA	1.00
R	97	130-05104-0013	4724-0104-233	RES CH 100K TW 5%	EA	1.00
R	98	130-05104-0013	4724-0104-233	RES CH 100K TW 5%	EA	1.00
REF	1	300-08830-0000	0008-5705-400	5W 30/12.5 R/T ASY	RF	X.
REF	2	002-08830-0000	0007-5705-400	SCH 5W 30/12.5 R/T	RF	X.
T	1	019-08135-0000	1800-2013-200	XFMR MIXER	EA	1.00
T	2	019-08134-0000	1800-2048-300	XFMR IFT	EA	1.00
T	3	019-08133-0000	1800-2048-200	XFMR IF	EA	1.00
Y	1	044-00152-0000	2301-2011-600	XTAL 17.355MHZ	EA	1.00

5 WATT RX/TX BOARD (NEW REVISION)

200-08293-0000
200-08293-0030EPH
EPI

(USE NEW REVISION DRAWING AND SCHEMATIC)

SYMBOL	OLD PART NO.	NEW PART NO.	DESCRIPTION	A	UM	EPH	EPI
B	2	013-00173-0000	2502-2022-300	FERRITE BEAD	EA	1.00	1.00
B	3	013-00173-0000	2502-2022-300	FERRITE BEAD	EA	1.00	1.00
B	4	013-00172-0000	2502-2022-200	FERR BEAD SRFC MT	EA	1.00	1.00
B	5	013-00173-0000	2502-2022-300	FERRITE BEAD	EA	1.00	1.00
B	7	013-00173-0000	2502-2022-300	FERRITE BEAD	EA	1.00	1.00
C	1	106-00072-0034	1553-5237-767	CAP CH 56PFNPO/50V	EA	1.00	.
C	1	106-00072-0038	1553-5237-783	CAP CH 82PFNPO/50V	EA	.	1.00
C	2	106-00072-0058	1553-5525-314	CAP CR CH 5.1PF	EA	1.00	.
C	2	106-00072-0059	1553-5313-522	CAP CH6.2PFNPO/50V	EA	.	1.00
C	3	106-00072-0046	1553-5237-788	CAP CH 1PF NPO/50V	EA	.	1.00
C	3	106-00072-0053	1553-5237-754	CAP CR CH 3.0PF	EA	1.00	.
C	4	106-05102-0016	1553-5313-582	CAP CH 1K NPO/50V	EA	1.00	1.00
C	5	106-00072-0020	1553-5237-798	CAP CH 20PFNPO/50V	EA	.	1.00
C	5	106-00072-0028	1553-5313-520	CAP CH 36PFNPO/50V	EA	1.00	.
C	6	106-00116-0049	1564-2042-549	CAP CHIP PORCELAIN	EA	1.00	.
C	6	106-00116-0053	1564-2042-553	CAP CHIP PORCELAIN	EA	.	1.00
C	7	106-00116-0049	1564-2042-549	CAP CHIP PORCELAIN	EA	1.00	.
C	7	106-00116-0053	1564-2042-553	CAP CHIP PORCELAIN	EA	.	1.00
C	8	106-05102-0047	1553-5237-733	CAP CH 1K X7R/50V	EA	1.00	1.00
C	9	106-05102-0016	1553-5313-582	CAP CH 1K NPO/50V	EA	1.00	1.00
C	10	106-05102-0047	1553-5237-733	CAP CH 1K X7R/50V	EA	1.00	1.00
C	11	106-00116-0049	1564-2042-549	CAP CHIP PORCELAIN	EA	1.00	.
C	11	106-00116-0053	1564-2042-553	CAP CHIP PORCELAIN	EA	.	1.00
C	12	106-00116-0049	1564-2042-549	CAP CHIP PORCELAIN	EA	1.00	.
C	12	106-00116-0053	1564-2042-553	CAP CHIP PORCELAIN	EA	.	1.00
C	13	106-04104-0047	1553-5237-780	CH 100KX7R/50V	EA	1.00	1.00
C	14	106-05102-0016	1553-5313-582	CAP CH 1K NPO/50V	EA	1.00	1.00
C	15	106-05102-0016	1553-5313-582	CAP CH 1K NPO/50V	EA	1.00	1.00
C	16	106-05103-0046	1553-5237-794	CAP CH 10K X7R/50V	EA	1.00	1.00
C	17	106-05102-0016	1553-5313-582	CAP CH 1K NPO/50V	EA	1.00	1.00
C	18	106-05102-0047	1553-5237-733	CAP CH 1K X7R/50V	EA	1.00	1.00
C	19	106-05102-0047	1553-5237-733	CAP CH 1K X7R/50V	EA	1.00	1.00
C	20	106-00072-0012	1553-5313-552	CAP CH 10PF NPO/50V	EA	1.00	.
C	20	106-00072-0014	1553-5237-779	CAP CH 12PF NPO/50V	EA	.	1.00
C	21	106-00072-0024	1553-5237-762	CAP CH 22PFNPO/50V	EA	.	1.00
C	21	106-00072-0032	1553-5237-769	CAP CH 47PFNPO/50V	EA	1.00	.
C	22	106-00072-0006	1553-5313-508	CAP CH 5.6PFNPO/50V	EA	.	1.00
C	22	106-00072-0010	1553-5313-551	CAP CH 8.2PFNPO/50V	EA	1.00	.
C	23	106-00072-0010	1553-5313-551	CAP CH 8.2PFNPO/50V	EA	1.00	.
C	23	106-00072-0024	1553-5237-762	CAP CH 22PFNPO/50V	EA	.	1.00
C	24	106-05102-0047	1553-5237-733	CAP CH 1K X7R/50V	EA	1.00	1.00
C	25	106-05102-0047	1553-5237-733	CAP CH 1K X7R/50V	EA	1.00	1.00
C	26	106-04104-0047	1553-5237-780	CH 100KX7R/50V	EA	1.00	1.00
C	28	106-05103-0046	1553-5237-794	CAP CH 10K X7R/50V	EA	1.00	1.00
C	29	106-05103-0046	1553-5237-794	CAP CH 10K X7R/50V	EA	1.00	1.00
C	30	106-05121-0016	1553-5313-503	CAP CH 120PFNPO/50V	EA	1.00	1.00
C	31	106-00072-0042	1553-5237-701	CAP CH 33PFNPO/50V	EA	1.00	1.00
C	33	106-04473-0048	1553-5237-782	CAP CH 47K X7R/50V	EA	1.00	1.00
C	34	106-04473-0048	1553-5237-782	CAP CH 47K X7R/50V	EA	1.00	1.00
C	35	106-05121-0016	1553-5313-503	CAP CH 120PFNPO/50V	EA	1.00	1.00
C	38	106-05561-0046	1553-5525-317	CH 560PF 7R/50V	EA	1.00	1.00
C	39	106-05121-0016	1553-5313-503	CAP CH 120PFNPO/50V	EA	1.00	1.00
C	40	106-05560-0016	1553-5237-767	CAP CH 56PFNPO/50V	EA	1.00	1.00
C	41	106-05122-0047	1553-5525-318	CAP CH 1200PFX7R/50V	EA	1.00	1.00
C	42	106-05222-0046	1553-5525-301	CAP CH 2.2KX7R/50V	EA	1.00	1.00
C	45	106-04104-0047	1553-5237-780	CH 100KX7R/50V	EA	1.00	1.00
C	46	106-00072-0018	1553-5237-777	CAP CH 18PFNPO/50V	EA	1.00	.
C	46	106-00072-0024	1553-5237-762	CAP CH 22PFNPO/50V	EA	.	1.00
C	47	106-05102-0047	1553-5237-733	CAP CH 1K X7R/50V	EA	1.00	1.00
C	48	106-05102-0047	1553-5237-733	CAP CH 1K X7R/50V	EA	1.00	1.00
C	49	106-00072-0026	1553-5237-763	CAP CH 27PFNPO/50V	EA	1.00	.

UCOM BOARD

200-08248-0000
PAGE 2

SYMBOL	OLD PART NO.	NEW PART NO.	DESCRIPTION	A	UM	0000	0010
C	129	106-04104-0047	1553-5237-780	CH 100KX7R/50V	EA	1.00	.
C	129	106-05104-0037	1553-5313-597	CAP CH 100KX7R/25V	EA	.	1.00
C	130	106-04683-0046	1553-5237-792	CAP CH 68KX7R 50V	EA	1.00	.
C	130	106-05104-0037	1553-5313-597	CAP CH 100KX7R/25V	EA	.	1.00
C	131	106-04560-0026		CAP CH56PFNPO/100V	EA	1.00	.
C	131	106-05560-0016	1553-5237-767	CAP CH 56PFNPO/50V	EA	.	1.00
C	132	106-04104-0047	1553-5237-780	CH 100KX7R/50V	EA	1.00	.
C	132	106-05104-0037	1553-5313-597	CAP CH 100KX7R/25V	EA	.	1.00
C	133	106-05221-0048	1553-5313-529	CAP CH 220X7R/50V	EA	.	1.00
C	133	111-00001-0094	1501-2062-500	CAP CR 220PF 50V	EA	1.00	.
C	135	106-00072-0040	1553-5313-531	CAP CH100PFNPO/50V	EA	.	1.00
C	136	106-00072-0040	1553-5313-531	CAP CH100PFNPO/50V	EA	.	1.00
C	138	106-00072-0053	1553-5237-754	CAP CH100PFNPO/50V	EA	.	1.00
C	139	106-00072-0040	1553-5313-531	CAP CH100PFNPO/50V	EA	.	1.00
C	145	096-01186-0059	1552-6463-137	CAP 4.7UF 10V 20%	EA	.	1.00
C	146	106-00072-0040	1553-5313-531	CAP CH100PFNPO/50V	EA	.	1.00
C	147	106-00072-0040	1553-5313-531	CAP CH100PFNPO/50V	EA	.	1.00
C	148	106-05104-0037	1553-5313-597	CAP CH 100KX7R/25V	EA	.	1.00
C	149	106-05104-0037	1553-5313-597	CAP CH 100KX7R/25V	EA	.	1.00
C	150	096-01186-0059	1552-6463-137	CAP 4.7UF 10V 20%	EA	.	1.00
C	152	096-01186-0062	1552-6463-121	CAP 1.0UF 16V 20%	EA	.	1.00
C	153	096-01186-0059	1552-6463-137	CAP 4.7UF 10V 20%	EA	.	1.00
C	155	106-00072-0040	1553-5313-531	CAP CH100PFNPO/50V	EA	.	1.00
C	156	106-00072-0040	1553-5313-531	CAP CH100PFNPO/50V	EA	.	1.00
C	157	106-00072-0040	1553-5313-531	CAP CH100PFNPO/50V	EA	.	1.00
C	158	106-00072-0040	1553-5313-531	CAP CH100PFNPO/50V	EA	.	1.00
C	159	106-00072-0040	1553-5313-531	CAP CH100PFNPO/50V	EA	.	1.00
C	160	106-00072-0040	1553-5313-531	CAP CH100PFNPO/50V	EA	.	1.00
C	161	106-00072-0040	1553-5313-531	CAP CH100PFNPO/50V	EA	.	1.00
CJ	1	130-05000-0015	4724-0000-009	RES CH 0 TW	EA	1.00	.
CR	1	007-06181-0000	4824-2009-500	DIO DUAL MMBD2835	EA	1.00	1.00
CR	3	007-05117-0007	4828-2009-200	DIO Z 6.2V SOT	EA	1.00	1.00
I	1	122-05011-0001	7019-2062-600	6805P9 OPT PRGMD	A EA	1.00	1.00
I	2	120-02160-0000	3134-2065-100	256 X 8 EPROM	EA	1.00	1.00
I	3	123-00574-0003	3134-2062-700	IC MOS 74HC574	EA	1.00	1.00
I	4	122-05014-0001	7019-2061-900	DSP OTP UCOM REV1	A EA	1.00	1.00
I	5	120-06259-0000	3134-2062-100	QUAL ANALOG SWITCH	EA	1.00	1.00
I	6	120-03426-0000	3134-2040-200	LMC660CM	EA	1.00	1.00
I	8	120-03127-0011	3134-2062-000	IC LM2903 SO PKG	EA	1.00	1.00
I	11	120-03196-0000	3134-3670-504	IC LM2902D	EA	1.00	1.00
I	12	123-00574-0003	3134-2062-700	IC MOS 74HC574	EA	1.00	1.00
I	15	120-03274-0000	3134-3670-403	VOLT REG LM2951ACM	EA	.	1.00
ITM	1	009-08248-0000	1700-6706-200	PC UCOM BD	EA	1.00	.
ITM	1	009-08248-0010	1700-6706-210	PCBD UCOM	EA	.	1.00
ITM	2	047-09999-0000	2508-2030-400	SHLD UCOM OPTION	EA	1.00	1.00
ITM	3	150-00003-0010	3101-0000-013	TUBING TFLN 24AWG	IN	0.50	.
ITM	4	016-01184-0000	1609-0000-004	ADHESIVE	AR	1.00	.
ITM	6	012-01440-0000	2512-2035-900	SPACER RESILIENT	EA	1.00	1.00
ITM	7	012-01005-0002	1601-2007-101	TAPE MYLAR .500 W	IN	0.50	1.00
J	9	030-01249-0004	2108-2002-501	SCKT MIN SPRING	EA	8.00	8.00
J	10	030-02905-0007	2105-4012-107	FLEX 7 POS	EA	1.00	1.00
P	7	030-02453-0006	2105-2001-906	CONNECTOR 12P	EA	1.00	1.00
P	8	030-02453-0006	2105-2001-906	CONNECTOR 12P	EA	1.00	1.00
Q	1	007-08064-0000	4823-2010-800	XSTR PNP 10K, 10K	EA	1.00	1.00
Q	2	007-08064-0014	4823-2010-814	XSTR PNP 4.7K, 10K	EA	.	1.00
Q	2	007-08064-0016	4823-3680-006	XSTR PNP 47K, 47K	EA	1.00	.
Q	3	007-00065-0001	4823-3669-001	XSTR 2N3906 (SOT)	EA	1.00	1.00
Q	4	007-00535-0000	4823-2020-201	XSTR JFET MMBF4393	EA	1.00	1.00
Q	8	007-00530-0001	4823-3669-101	XSTR NPN MMBT3904	EA	1.00	1.00
Q	9	007-08064-0017	4823-2010-817	XSTR NPN 47K, 47K	EA	1.00	1.00
Q	10	007-00530-0001	4823-3669-101	XSTR NPN MMBT3904	EA	1.00	1.00
R	2	130-05103-0013	4724-0103-233	RES CH 10K TW 5%	EA	.	1.00
R	2	130-05103-0023	4718-5237-310	RES CH 10K EW 5%	EA	1.00	.
R	3	130-05152-0013	4724-0152-233	RES CH 1.5K TW 5%	EA	.	1.00
R	3	139-01502-0000	4718-5313-166	RES CHIP 15K EW 1%	EA	1.00	.
R	4	130-05334-0013	4724-0334-233	RES CH 330K TW 5%	EA	.	1.00
R	4	139-03323-0000	4718-5317-189	RES CH 332K EW 1%	EA	1.00	.

5 WATT RX/TX BOARD (NEW REVISION)

200-08293-0000
200-08293-0030
PAGE 3

EPH
EPI

SYMBOL	OLD PART NO.	NEW PART NO.	DESCRIPTION	A	UM	EPH	EPI
CR 2	007-04134-0000	4809-2047-100	VARACTOR SET OF 4		EA	1.00	1.00
CR 6	007-06188-0000	4824-2008-600	DIO HOT CARRIER		EA	1.00	1.00
CR 7	007-06188-0000	4824-2008-600	DIO HOT CARRIER		EA	1.00	1.00
CR 8	007-06188-0000	4824-2008-600	DIO HOT CARRIER		EA	1.00	1.00
CR 9	007-06188-0000	4824-2008-600	DIO HOT CARRIER		EA	1.00	1.00
CR 13	007-06418-0000	4824-2047-300	PIN DIODE		EA	1.00	1.00
CR 14	007-06226-0001	4824-2021-800	SOT23 DIO MMBD352		EA	1.00	1.00
FL 1	017-00096-0000	2705-2022-600	XTAL FLTR 16.9MHZ		EA	1.00	.
FL 1	017-00237-0000	2705-2092-900	FLTR XTAL 14.0 MHZ		EA	.	1.00
FL 2	017-00106-0000	2700-2011-200	FLTR CR 455KHZ		EA	1.00	1.00
FL 3	017-00137-0000	2701-2047-500	DISCRIMINATOR CER.		EA	1.00	1.00
I 2	120-03193-0000	3134-2005-500	IC FM/F MC3357D		EA	1.00	1.00
I 3	120-03473-0000	3134-2082-200	OP AMP		EA	1.00	1.00
ITM 1	009-08293-0010	1700-5707-310	PCBD RXTX	A	EA	1.00	1.00
ITM 4	091-00320-0000	3105-2001-200	INSUL TO-5		EA	1.00	1.00
ITM 5	078-01455-0001	5400-2027-501	ADAPTOR W/FIN	A	EA	1.00	1.00
ITM 8	016-01124-0002	1601-2000-903	FOAM TAPE .38W		IN	0.35	0.35
ITM 9	016-01124-0002	1601-2000-903	FOAM TAPE .38W		IN	0.35	0.35
ITM 10	016-01124-0002	1601-2000-903	FOAM TAPE .38W		IN	0.50	0.50
ITM 11	047-06735-0001	2508-2001-601	CAN DUAL COIL		EA	2.00	2.00
ITM 12	047-06707-0001	2508-2029-401	GROUND LUG XSTR		EA	1.00	1.00
ITM 14	026-00027-0000	6018-0000-001	WIRE CU18AWG TIN		IN	0.18	.
ITM 14	026-00037-0000		WIRE CU38AWG TIN		IN	.	0.18
J 1	030-01386-0001	2108-2017-401	SCKT MINATURE SPRG		EA	3.00	3.00
J 2	030-01386-0001	2108-2017-401	SCKT MINATURE SPRG		EA	8.00	8.00
J 3	030-00417-0000	2105-2017-300	20 DGR CONN RCPTBL		EA	1.00	1.00
L 1	019-02660-0048	1808-2013-648	INDUCT SURF MT		EA	1.00	.
L 1	019-02660-0049	1808-2013-649	INDUCT SURFACE MT		EA	.	1.00
L 2	019-02701-0001	1800-2048-101	MOLDED INDUCT		EA	1.00	1.00
L 3	019-02701-0002	1800-2048-102	MOLDED INDUCTOR		EA	1.00	1.00
L 4	019-02701-0002	1800-2048-102	MOLDED INDUCTOR		EA	1.00	1.00
L 5	019-02701-0000	1800-2048-100	MOLDED INDUCTOR		EA	1.00	1.00
L 7	019-02660-0050	1808-2013-650	INDUCT SURF MT		EA	1.00	1.00
L 8	019-02660-0045	1808-2013-645	INDUCT SURF MT		EA	1.00	.
L 8	019-02660-0046	1808-2013-646	INDUCT SURF MT		EA	.	1.00
L 10	019-02660-0045	1808-2013-645	INDUCT SURF MT		EA	.	1.00
L 10	019-02660-0047	1808-2013-647	INDUCT SURF MT		EA	1.00	.
L 11	019-02660-0003	1808-2013-603	INDUCT SURFACE MT		EA	1.00	1.00
L 12	019-02660-0044	1808-2013-644	INDUCT SURF MT		EA	1.00	1.00
L 14	019-02660-0003	1808-2013-603	INDUCT SURFACE MT		EA	1.00	1.00
L 16	019-02660-0044	1808-2013-644	INDUCT SURF MT		EA	1.00	1.00
L 17	019-02660-0013	1808-2013-613	INDUCT SURFACE MT		EA	1.00	1.00
L 18	019-02404-0003	1801-2048-003	COIL 3T		EA	1.00	1.00
L 21	019-02660-0030	1808-2013-630	INDUCT SM 1.5 10%		EA	1.00	1.00
L 22	019-02404-0005	1801-2048-005	4TX.070 24AWG		EA	1.00	.
L 22	019-02717-0004	1801-2023-304	COIL 4TX.100 #24		EA	.	1.00
L 23	019-02404-0003	1801-2048-003	COIL 3T		EA	1.00	.
L 23	019-02717-1403	1801-2023-300	COIL 3TX.114 #24		EA	.	1.00
L 24	019-02717-2004	1801-2023-307	COIL 4TX.120 #24		EA	1.00	1.00
L 25	019-02717-4204	1801-2023-305	COIL 4TX.142 #24		EA	.	1.00
L 25	019-02717-4604	1801-2023-306	COIL 4TX.146 #24		EA	1.00	.
L 26	019-02717-4204	1801-2023-305	COIL 4TX.142 #24		EA	1.00	.
L 26	019-02717-4604	1801-2023-306	COIL 4TX.146 #24		EA	.	1.00
Q 1	007-00943-0000	4823-2025-300	XSTR RF NPN		EA	1.00	1.00

UCOM BOARD

200-08248-0000
PAGE 4

SYMBOL	OLD PART NO.	NEW PART NO.	DESCRIPTION	A	UM	0000	0010
R	146	130-05471-0013	4724-0471-233	RES CH 470 TW 5%	EA	.	1.00
R	146	130-05471-0023	4718-5237-318	RES CHIP 470EW5%	EA	1.00	.
R	147	130-05104-0013	4724-0104-233	RES CH 100K TW 5%	EA	.	1.00
R	147	130-05104-0023	4718-5237-322	RES CH 100K EW 5%	EA	1.00	.
R	148	130-05104-0013	4724-0104-233	RES CH 100K TW 5%	EA	.	1.00
R	148	130-05104-0023	4718-5237-322	RES CH 100K EW 5%	EA	1.00	.
R	149	130-05273-0013	4724-0273-233	RES CH 27K TW 5%	EA	.	1.00
R	149	139-02672-0000	4718-5398-940	RES CHIP 26.7KEW1%	EA	1.00	.
R	150	130-05303-0013	4724-0303-233	RES CH 30K TW 5%	EA	.	1.00
R	150	130-05303-0023	4718-5237-338	RES CHIP 30KEW5%	EA	1.00	.
R	151	130-05104-0013	4724-0104-233	RES CH 100K TW 5%	EA	.	1.00
R	151	130-05104-0023	4718-5237-322	RES CH 100K EW 5%	EA	1.00	.
R	152	130-05102-0013	4724-0102-233	RES CH 1K TW 5%	EA	.	1.00
R	152	139-01001-0000	4718-5237-315	RES CHIP 1K EW 1%	EA	1.00	.
R	153	130-05242-0013	4724-0242-233	RES CH 2.4K TW 5%	EA	.	1.00
R	153	130-05242-0023	4718-5237-372	RES CHIP 2.4KEW5%	EA	1.00	.
R	154	130-05104-0013	4724-0104-233	RES CH 100K TW 5%	EA	.	1.00
R	154	130-05104-0023	4718-5237-322	RES CH 100K EW 5%	EA	1.00	.
R	156	130-05512-0013	4724-0512-233	RES CH 5.1K TW 5%	EA	.	1.00
R	156	130-05512-0023	4718-5237-355	RES CHIP 5.1KEW5%	EA	1.00	.
R	157	130-05105-0013	4724-0105-233	RES CH 1 MEG TW 5%	EA	.	1.00
R	157	130-05105-0023	4718-5237-367	RES CHIP 1M EW 5%	EA	1.00	.
R	158	130-05101-0013	4724-0101-233	RES CH 100 TW 5%	EA	.	1.00
R	159	130-05473-0013	4724-0473-233	RES CH 47K TW 5%	EA	.	1.00
R	160	130-05473-0013	4724-0473-233	RES CH 47K TW 5%	EA	.	1.00
R	163	130-05000-0015	4724-0000-009	RES CH 0 TW	EA	.	1.00
R	164	130-05000-0015	4724-0000-009	RES CH 0 TW	EA	.	1.00
R	165	130-05000-0015	4724-0000-009	RES CH 0 TW	EA	.	1.00
R	166	130-05000-0015	4724-0000-009	RES CH 0 TW	EA	.	1.00
R	167	130-05000-0015	4724-0000-009	RES CH 0 TW	EA	.	1.00
R	168	130-05102-0013	4724-0102-233	RES CH 1K TW 5%	EA	.	1.00
R	169	130-05102-0013	4724-0102-233	RES CH 1K TW 5%	EA	.	1.00
R	170	130-05102-0013	4724-0102-233	RES CH 1K TW 5%	EA	.	1.00
R	171	130-05102-0013	4724-0102-233	RES CH 1K TW 5%	EA	.	1.00
R	172	130-05102-0013	4724-0102-233	RES CH 1K TW 5%	EA	.	1.00
R	175	130-05100-0013	4724-0100-233	RES CH 10 TW 5%	EA	.	1.00
R	176	130-05100-0013	4724-0100-233	RES CH 10 TW 5%	EA	.	1.00
R	177	130-05100-0013	4724-0100-233	RES CH 10 TW 5%	EA	.	1.00
R	178	130-05100-0013	4724-0100-233	RES CH 10 TW 5%	EA	.	1.00
R	179	130-05100-0013	4724-0100-233	RES CH 10 TW 5%	EA	.	1.00
REF	1	002-08248-0000	0007-6706-200	SCH UCOM BD	RF	X.	.
REF	2	300-08248-0000	0008-6706-200	UCOM BD ASSY	RF	X.	.
REF	3	002-08248-0010	0007-6706-210	SCH UCOM BD	RF	.	X.
REF	4	300-08248-0010	0008-6706-210	ASY UCOM BD	RF	.	X.
RN	2	015-00208-0006	4726-2041-606	R/2R NETWORK	EA	1.00	1.00
Y	1	044-00155-0000	2342-2062-400	XTAL 16.000000MHZ	EA	1.00	1.00
Y	2	044-00302-0000	2342-2062-300	XTAL 4.194304MHZ	EA	1.00	1.00

5 WATT RX/TX BOARD (FLEX)

200-08830-0000

EPH

SYMBOL	OLD PART NO.	NEW PART NO.	DESCRIPTION	A	UM	EPH
B	2	013-00173-0000	2502-2022-300	FERRITE BEAD	EA	1.00
B	3	013-00173-0000	2502-2022-300	FERRITE BEAD	EA	1.00
B	4	013-00172-0000	2502-2022-200	FERR BEAD SRFC MT	EA	1.00
B	5	013-00173-0000	2502-2022-300	FERRITE BEAD	EA	1.00
B	7	013-00173-0000	2502-2022-300	FERRITE BEAD	EA	1.00
C	1	106-00072-0034	1553-5237-767	CAP CH 56PFNPO/50V	EA	1.00
C	2	106-00072-0058	1553-5525-314	CAP CR CH 5.1PF	EA	1.00
C	3	106-00072-0053	1553-5237-754	CAP CR CH 3.0PF	EA	1.00
C	4	106-05102-0016	1553-5313-582	CAP CH 1K NPO/50V	EA	1.00
C	5	106-00072-0028	1553-5313-520	CAP CH 36PFNPO/50V	EA	1.00
C	6	106-00116-0049	1564-2042-549	CAP CHIP PORCELAIN	EA	1.00
C	7	106-00116-0049	1564-2042-549	CAP CHIP PORCELAIN	EA	1.00
C	8	106-05102-0047	1553-5237-733	CAP CH 1K X7R/50V	EA	1.00
C	9	106-05102-0016	1553-5313-582	CAP CH 1K NPO/50V	EA	1.00
C	10	106-05102-0047	1553-5237-733	CAP CH 1K X7R/50V	EA	1.00
C	11	106-00116-0049	1564-2042-549	CAP CHIP PORCELAIN	EA	1.00
C	12	106-00116-0049	1564-2042-549	CAP CHIP PORCELAIN	EA	1.00
C	13	106-04104-0047	1553-5237-780	CH 100KX7R/50V	EA	1.00
C	14	106-05102-0016	1553-5313-582	CAP CH 1K NPO/50V	EA	1.00
C	15	106-05102-0016	1553-5313-582	CAP CH 1K NPO/50V	EA	1.00
C	16	106-05103-0046	1553-5237-794	CAP CH 10K X7R/50V	EA	1.00
C	17	106-05102-0016	1553-5313-582	CAP CH 1K NPO/50V	EA	1.00
C	18	106-05102-0047	1553-5237-733	CAP CH 1K X7R/50V	EA	1.00
C	19	106-05102-0047	1553-5237-733	CAP CH 1K X7R/50V	EA	1.00
C	20	106-00072-0012	1553-5313-552	CAP CH 10PF NPO/50V	EA	1.00
C	21	106-00072-0031	1553-5525-320	CAP CH 39PFNPO/50V	EA	1.00
C	22	106-00072-0010	1553-5313-551	CAP CH 8.2PFNPO/50V	EA	1.00
C	24	106-05102-0047	1553-5237-733	CAP CH 1K X7R/50V	EA	1.00
C	25	106-05102-0047	1553-5237-733	CAP CH 1K X7R/50V	EA	1.00
C	26	106-05104-0078	1553-5525-316	CAP CH 100KZ5U/50V	EA	1.00
C	28	106-05103-0046	1553-5237-794	CAP CH 10K X7R/50V	EA	1.00
C	29	106-05103-0046	1553-5237-794	CAP CH 10K X7R/50V	EA	1.00
C	30	106-05121-0016	1553-5313-503	CAP CH 120PFNPO/50V	EA	1.00
C	31	106-00072-0042	1553-5237-701	CAP CH 33PFNPO/50V	EA	1.00
C	32	106-05102-0047	1553-5237-733	CAP CH 1K X7R/50V	EA	1.00
C	33	106-04473-0048	1553-5237-782	CAP CH 47K X7R/50V	EA	1.00
C	34	106-04473-0048	1553-5237-782	CAP CH 47K X7R/50V	EA	1.00
C	35	106-05121-0016	1553-5313-503	CAP CH 120PFNPO/50V	EA	1.00
C	37	106-05103-0046	1553-5237-794	CAP CH 10K X7R/50V	EA	1.00
C	38	106-05561-0046	1553-5525-317	CH 560PF 7R/50V	EA	1.00
C	39	106-05121-0016	1553-5313-503	CAP CH 120PFNPO/50V	EA	1.00
C	40	106-05560-0016	1553-5237-767	CAP CH 56PFNPO/50V	EA	1.00
C	41	106-05122-0047	1553-5525-318	CAPCH1200PFX7R/50V	EA	1.00
C	42	106-05222-0046	1553-5525-301	CAP CH 2.2KX7R/50V	EA	1.00
C	43	096-01186-0062	1552-6463-121	CAP 1.0UF 16V 20%	EA	1.00
C	44	106-00072-0016	1553-5313-504	CAP CH 15PFNPO/50V	EA	1.00
C	45	106-04104-0047	1553-5237-780	CH 100KX7R/50V	EA	1.00
C	46	106-00072-0018	1553-5237-777	CAP CH 18PFNPO/50V	EA	1.00
C	47	106-05102-0047	1553-5237-733	CAP CH 1K X7R/50V	EA	1.00
C	48	106-05102-0047	1553-5237-733	CAP CH 1K X7R/50V	EA	1.00
C	49	106-00072-0026	1553-5237-763	CAP CH 27PFNPO/50V	EA	1.00
C	50	096-01186-0062	1552-6463-121	CAP 1.0UF 16V 20%	EA	1.00
C	51	106-05102-0047	1553-5237-733	CAP CH 1K X7R/50V	EA	1.00
C	52	106-00072-0032	1553-5237-769	CAP CH 47PFNPO/50V	EA	1.00
C	53	106-00072-0036	1553-5237-789	CAP CH 68PFNPO/50V	EA	1.00
C	54	106-05102-0047	1553-5237-733	CAP CH 1K X7R/50V	EA	1.00
C	55	106-04104-0047	1553-5237-780	CH 100KX7R/50V	EA	1.00
C	56	106-05102-0047	1553-5237-733	CAP CH 1K X7R/50V	EA	1.00
C	57	106-00072-0032	1553-5237-769	CAP CH 47PFNPO/50V	EA	1.00
C	58	106-00072-0036	1553-5237-789	CAP CH 68PFNPO/50V	EA	1.00
C	59	106-00072-0036	1553-5237-789	CAP CH 68PFNPO/50V	EA	1.00
C	60	106-05102-0047	1553-5237-733	CAP CH 1K X7R/50V	EA	1.00
C	61	106-04104-0047	1553-5237-780	CH 100KX7R/50V	EA	1.00
C	62	106-00072-0032	1553-5237-769	CAP CH 47PFNPO/50V	EA	1.00
C	63	106-00072-0024	1553-5237-762	CAP CH 22PFNPO/50V	EA	1.00
C	64	106-00072-0032	1553-5237-769	CAP CH 47PFNPO/50V	EA	1.00
C	65	106-00072-0032	1553-5237-769	CAP CH 47PFNPO/50V	EA	1.00
C	66	106-00072-0024	1553-5237-762	CAP CH 22PFNPO/50V	EA	1.00
C	67	106-00072-0060	1553-5313-517	CAP CR CH 7.5PF	EA	1.00
C	68	106-00072-0059	1553-5313-522	CAP CH 6.2PFNPO/50V	EA	1.00
C	69	106-00072-0014	1553-5237-779	CAP CH 12PFNPO/50V	EA	1.00
C	70	106-00072-0058	1553-5525-314	CAP CR CH 5.1PF	EA	1.00



5 WATT RX/TX BOARD (FLEX)

200-08830-0000
PAGE 3

EPH

SYMBOL	OLD PART NO.	NEW PART NO.	DESCRIPTION	A	UM	EPH
L	2	019-02701-0001	1800-2048-101	MOLDED INDUCT	EA	1.00
L	3	019-02701-0002	1800-2048-102	MOLDED INDUCTOR	EA	1.00
L	4	019-02701-0002	1800-2048-102	MOLDED INDUCTOR	EA	1.00
L	5	019-02701-0000	1800-2048-100	MOLDED INDUCTOR	EA	1.00
L	7	019-02660-0050	1808-2013-650	INDUCT SURF MT	EA	1.00
L	8	019-02660-0045	1808-2013-645	INDUCT SURF MT	EA	1.00
L	10	019-02660-0047	1808-2013-647	INDUCT SURF MT	EA	1.00
L	11	019-02660-0003	1808-2013-603	INDUCT SURFACE MT	EA	1.00
L	12	019-02660-0044	1808-2013-644	INDUCT SURF MT	EA	1.00
L	14	019-02660-0003	1808-2013-603	INDUCT SURFACE MT	EA	1.00
L	16	019-02660-0044	1808-2013-644	INDUCT SURF MT	EA	1.00
L	17	019-02660-0013	1808-2013-613	INDUCT SURFACE MT	EA	1.00
L	18	019-02404-0003	1801-2048-003	COIL 3T	EA	1.00
L	21	019-02660-0030	1808-2013-630	INDUCT SM 1.5 10%	EA	1.00
L	22	019-02404-0005	1801-2048-005	4TX.070 24AWG	EA	1.00
L	23	019-02404-0003	1801-2048-003	COIL 3T	EA	1.00
L	24	019-02717-2004	1801-2023-307	COIL 4TX.120 #24	EA	1.00
L	25	019-02717-4604	1801-2023-306	COIL 4TX.146 #24	EA	1.00
L	26	019-02717-4204	1801-2023-305	COIL 4TX.142 #24	EA	1.00
Q	1	007-00943-0000	4823-2025-300	XSTR RF NPN	EA	1.00
Q	2	007-08064-0017	4823-2010-817	XSTR NPN 47K, 47K	EA	1.00
Q	3	007-08064-0015	4823-2010-815	TSTR DIGITAL SO	EA	1.00
Q	4	007-00529-0000	4823-2006-400	XSTR NPN MMBTH24	EA	1.00
Q	5	007-00942-0000	4823-2046-700	XSTR P-CH MOSFET	EA	1.00
Q	6	007-00187-0002	4823-3741-401	XSTR SOT-23 2N5089	EA	1.00
Q	7	007-00539-0000	4823-1367-900	XSTR MMBTH10	EA	1.00
Q	8	007-00907-0000	4823-2008-300	XSTR BFQ17	EA	1.00
Q	9	007-00936-0000	4823-2046-600	PUR MOSFET N-CHNL	EA	1.00
Q	10	007-00545-0000	4804-2009-000	XSTR RF PWE 2N6255	EA	1.00
Q	11	007-00538-0000	4804-2008-900	XSTR RF POWER	EA	1.00
Q	12	007-08064-0014	4823-2010-814	XSTR PNP 4.7K, 10K	EA	1.00
Q	13	007-00943-0000	4823-2025-300	XSTR RF NPN	EA	1.00
Q	14	007-00982-0000	4823-2020-600	MSFET TETRODE N-CH	EA	1.00
Q	16	007-00982-0000	4823-2020-600	MSFET TETRODE N-CH	EA	1.00
Q	17	007-00982-0000	4823-2020-600	MSFET TETRODE N-CH	EA	1.00
Q	18	007-00982-0000	4823-2020-600	MSFET TETRODE N-CH	EA	1.00
Q	19	007-00982-0000	4823-2020-600	MSFET TETRODE N-CH	EA	1.00
Q	20	007-00982-0000	4823-2020-600	MSFET TETRODE N-CH	EA	1.00
Q	23	007-08064-0017	4823-2010-817	XSTR NPN 47K, 47K	EA	1.00
Q	24	007-00903-0000	4823-2025-100	2N7002 MOSFET	EA	1.00
Q	25	007-00982-0000	4823-2020-600	MSFET TETRODE N-CH	EA	1.00
Q	26	007-00982-0000	4823-2020-600	MSFET TETRODE N-CH	EA	1.00
R	1	130-05334-0013	4724-0334-233	RES CH 330K TW 5%	EA	1.00
R	2	130-05101-0013	4724-0101-233	RES CH 100 TW 5%	EA	1.00
R	3	130-05101-0013	4724-0101-233	RES CH 100 TW 5%	EA	1.00
R	4	130-05124-0013	4724-0124-233	RES CH 120K TW 5%	EA	1.00
R	5	130-05124-0013	4724-0124-233	RES CH 120K TW 5%	EA	1.00
R	7	130-05511-0023	4718-5317-149	RES CHIP 510 EW 5%	EA	1.00
R	8	130-05103-0013	4724-0103-233	RES CH 10K TW 5%	EA	1.00
R	9	130-05221-0023	4718-5237-323	RES CHIP 220 EW 5%	EA	1.00
R	10	130-05103-0013	4724-0103-233	RES CH 10K TW 5%	EA	1.00
R	11	130-05124-0023	4718-5237-359	RES CHIP 120KEW5%	EA	1.00
R	12	130-05124-0023	4718-5237-359	RES CHIP 120KEW5%	EA	1.00
R	13	130-05103-0023	4718-5237-310	RES CH 10K EW 5%	EA	1.00
R	14	130-09003-0000	4728-0019-945	RES CH 0.10 10% QS	EA	1.00
R	15	130-05273-0013	4724-0273-233	RES CH 27K TW 5%	EA	1.00
R	16	130-05222-0013	4724-0222-233	RES CH 2.2K TW 5%	EA	1.00
R	17	130-05104-0013	4724-0104-233	RES CH 100K TW 5%	EA	1.00
R	18	130-05301-0013	4724-0301-233	RES CH 300 TW 5%	EA	1.00
R	19	130-05183-0023	4718-5237-378	RES CHIP 18KEW5%	EA	1.00
R	20	130-05472-0023	4718-5237-303	RES CHIP 4.7KEW5%	EA	1.00
R	21	130-05101-0013	4724-0101-233	RES CH 100 TW 5%	EA	1.00
R	22	130-05753-0013	4724-0753-233	RES CH 75K TW 5%	EA	1.00
R	23	130-05202-0013	4724-0202-233	RES CH 2K TW 5%	EA	1.00
R	24	130-05202-0023	4718-5317-151	RES CHIP 2K EW 5%	EA	1.00
R	25	130-05473-0013	4724-0473-233	RES CHIP 47K TW 5%	EA	1.00
R	26	130-05152-0023	4718-5237-319	RES CHIP 1.5KEW5%	EA	1.00
R	28	133-00271-0008	4719-2046-208	RES VAS 2.2K 100V	EA	1.00
R	29	130-05392-0013	4724-0392-233	RES CH 3.9K TW 5%	EA	1.00
R	30	130-05471-0013	4724-0471-233	RES CH 470 TW 5%	EA	1.00
R	31	130-05154-0013	4724-0154-233	RES CH 150K TW 5%	EA	1.00

BENDIX/KING

BK Radio, Inc.
2901 Lakeview Road
Lawrence, KS 66049

© Copyright 1995 BK Radio, Inc. All rights reserved.

LAA 0008
BK Radio Ref. 006-01202-0001

P/N 0300-2066-801

UCOM BOARD

200-08248-0000
200-08248-0010EARLY UCOM BOARD
LATER UCOM BOARD

SYMBOL	OLD PART NO.	NEW PART NO.	DESCRIPTION	A	UM	0000	0010
C	1	106-00072-0040	1553-5313-531	CAP CH100PFNPO/50V	EA	.	1.00
C	1	106-04101-0016	1553-5237-719	CH 100PF NPO/50V	EA	1.00	.
C	2	106-00072-0040	1553-5313-531	CAP CH100PFNPO/50V	EA	.	1.00
C	2	106-04101-0016	1553-5237-719	CH 100PF NPO/50V	EA	1.00	.
C	3	106-04150-0026		CH 15PF NPO/100V	EA	1.00	.
C	3	106-05150-0026	1553-5313-598	CAP CH15PFNPO/100V	EA	.	1.00
C	4	106-04150-0026		CH 15PF NPO/100V	EA	1.00	.
C	4	106-05150-0026	1553-5313-598	CAP CH15PFNPO/100V	EA	.	1.00
C	5	106-04150-0026		CH 15PF NPO/100V	EA	1.00	.
C	5	106-05150-0026	1553-5313-598	CAP CH15PFNPO/100V	EA	.	1.00
C	6	106-04150-0026		CH 15PF NPO/100V	EA	1.00	.
C	6	106-05150-0026	1553-5313-598	CAP CH15PFNPO/100V	EA	.	1.00
C	8	106-04560-0016	1553-5525-321	CAP CH 56PFNPO/50V	EA	1.00	.
C	8	106-05560-0016	1553-5237-767	CAP CH 56PFNPO/50V	EA	.	1.00
C	9	106-00072-0040	1553-5313-531	CAP CH100PFNPO/50V	EA	.	1.00
C	9	106-04101-0016	1553-5237-719	CH 100PF NPO/50V	EA	1.00	.
C	10	106-04472-0057	1553-5525-307	CAPCH4700PFX74/100	EA	1.00	.
C	10	106-05472-0046	1553-5237-785	CAP CH 4.7KX7R/50V	EA	.	1.00
C	11	106-04154-0078	1553-5525-306	CAP CH 150K25U/50V	EA	1.00	.
C	11	106-05154-0078	1553-5525-599	CAP CER 150K25U/50	EA	.	1.00
C	12	106-04104-0047	1553-5237-780	CH 100KX7R/50V	EA	1.00	.
C	12	106-05104-0037	1553-5313-597	CAP CH 100KX7R/25V	EA	.	1.00
C	13	106-04272-0046	1553-5313-574	CAP CH 2.7KX7R/50V	EA	1.00	.
C	13	106-05272-0047	1553-5525-302	CAPCH2700PFX7R/50V	EA	.	1.00
C	14	106-04104-0047	1553-5237-780	CH 100KX7R/50V	EA	1.00	.
C	14	106-05104-0037	1553-5313-597	CAP CH 100KX7R/25V	EA	.	1.00
C	15	096-01186-0026	1552-6463-116	CAP .22UF 35V 10%	EA	1.00	1.00
C	16	106-04103-0047	1553-5237-705	CH 10K X7R/50V	EA	1.00	.
C	16	106-05103-0047	1553-5237-734	CAP CH 10K X7R/50V	EA	.	1.00
C	17	106-00072-0040	1553-5313-531	CAP CH100PFNPO/50V	EA	.	1.00
C	17	106-04101-0016	1553-5237-719	CH 100PF NPO/50V	EA	1.00	.
C	19	106-04682-0057	1553-5525-309	CAPCH6800PFX7R/100	EA	1.00	.
C	19	106-05682-0046	1553-5237-797	CAP CH 6.8KX7R/50V	EA	.	1.00
C	21	106-04150-0026		CH 15PF NPO/100V	EA	1.00	.
C	21	106-05150-0026	1553-5313-598	CAP CH15PFNPO/100V	EA	.	1.00
C	22	106-04272-0046	1553-5313-574	CAP CH 2.7KX7R/50V	EA	1.00	.
C	22	106-05272-0047	1553-5525-302	CAPCH2700PFX7R/50V	EA	.	1.00
C	25	096-01186-0074	1552-6463-138	CAP 1UF 35V 20%	EA	1.00	1.00
C	30	106-00072-0040	1553-5313-531	CAP CH100PFNPO/50V	EA	.	1.00
C	30	106-04101-0016	1553-5237-719	CH 100PF NPO/50V	EA	1.00	.
C	31	096-01186-0067	1552-6463-131	CAP 2.2UF 20V 20%	EA	1.00	1.00
C	32	106-04102-0016	1553-5237-703	CAP CH 1K NPO/50V	EA	1.00	.
C	32	106-05102-0047	1553-5237-733	CAP CH 1K X7R/50V	EA	.	1.00
C	33	096-01186-0062	1552-6463-121	CAP 1.0UF 16V 20%	EA	1.00	1.00
C	35	106-04333-0046	1553-5237-791	CAP CH 33K X7R/50V	EA	1.00	.
C	35	106-05333-0036	1553-5313-526	CAP CH 33K X7R/25V	EA	.	1.00
C	36	106-04222-0046	1553-5313-573	CAP CH 2.2K 50V 5%	EA	1.00	.
C	36	106-05222-0046	1553-5525-301	CAP CH 2.2KX7R/50V	EA	.	1.00
C	37	106-04563-0046	1553-5313-542	CAP CH 56K X7R/50V	EA	1.00	.
C	37	106-05563-0036	1553-5525-303	CAP CH 56K X7R/25V	EA	.	1.00
C	38	106-04101-0016	1553-5237-719	CH 100PF NPO/50V	EA	1.00	.
C	39	106-00072-0040	1553-5313-531	CAP CH100PFNPO/50V	EA	.	1.00
C	39	106-04101-0016	1553-5237-719	CH 100PF NPO/50V	EA	1.00	.
C	40	106-00072-0040	1553-5313-531	CAP CH100PFNPO/50V	EA	.	1.00
C	40	106-04101-0016	1553-5237-719	CH 100PF NPO/50V	EA	1.00	.
C	120	106-04272-0046	1553-5313-574	CAP CH 2.7KX7R/50V	EA	1.00	.
C	120	106-05272-0047	1553-5525-302	CAPCH2700PFX7R/50V	EA	.	1.00
C	121	106-04103-0047	1553-5237-705	CH 10K X7R/50V	EA	1.00	.
C	121	106-05103-0048	1553-5237-794	CAP CH 10K X7R/50V	EA	.	1.00
C	122	106-00072-0040	1553-5313-531	CAP CH100PFNPO/50V	EA	.	1.00
C	122	106-04101-0016	1553-5237-719	CH 100PF NPO/50V	EA	1.00	.
C	123	096-01186-0062	1552-6463-121	CAP 1.0UF 16V 20%	EA	1.00	1.00
C	124	106-04273-0046	1553-5313-540	CAP CH 27K X7R/50V	EA	1.00	.
C	124	106-05273-0037	1553-5525-304	CAP CH 27K X7R/25V	EA	.	1.00
C	125	106-04154-0078	1553-5525-306	CAP CH 150K25U/50V	EA	1.00	.
C	125	106-05154-0078	1553-5313-599	CAP CER 150K25U/50	EA	.	1.00
C	126	106-04821-0016	1553-5313-544	CAP CH820PFNPO/50V	EA	1.00	.
C	126	106-05102-0046	1553-5237-787	CAP CH 1K X7R/50V	EA	.	1.00
C	127	106-04102-0016	1553-5237-703	CAP CH 1K NPO/50V	EA	1.00	.
C	127	106-05102-0046	1553-5237-787	CAP CH 1K X7R/50V	EA	.	1.00
C	128	106-04560-0026		CAP CH56PFNPO/100V	EA	1.00	.
C	128	106-05560-0016	1553-5237-767	CAP CH 56PFNPO/50V	EA	.	1.00

UCOM BOARD

200-08248-0000
PAGE 3

SYMBOL	OLD PART NO.	NEW PART NO.	DESCRIPTION	A	UM	0000	0010
R	5	130-05222-0013	4724-0222-233	RES CH 2.2K TW 5%	EA	.	1.00
R	5	130-05222-0023	4718-5237-331	RES CHIP 2.2KEW5%	EA	1.00	.
R	6	130-05222-0013	4724-0222-233	RES CH 2.2K TW 5%	EA	.	1.00
R	6	139-02211-0000		RES CH 2.21K EW 1%	EA	1.00	.
R	8	130-05472-0013	4724-0472-233	RES CH 4.7K TW 5%	EA	.	1.00
R	8	130-05472-0023	4718-5237-303	RES CHIP 4.7KEW5%	EA	1.00	.
R	9	130-05105-0013	4724-0105-233	RES CH 1 MEG TW 5%	EA	.	1.00
R	9	130-05105-0023	4718-5237-367	RES CHIP 1M EW 5%	EA	1.00	.
R	10	130-05103-0013	4724-0103-233	RES CH 10K TW 5%	EA	.	1.00
R	10	130-05103-0023	4718-5237-310	RES CH 10K EW 5%	EA	1.00	.
R	11	130-05104-0013	4724-0104-233	RES CH 100K TW 5%	EA	.	1.00
R	11	139-01053-0000		RES CHIP 105K EW 1	EA	1.00	.
R	12	130-05104-0013	4724-0104-233	RES CH 100K TW 5%	EA	.	1.00
R	12	139-01003-0000	4718-5317-138	RES CHIP 100KEW1%	EA	1.00	.
R	14	130-05473-0023	4718-5237-324	RES CHIP 47KEW5%	EA	.	1.00
R	14	139-04752-0000	4718-5317-122	RES CH 47.5K EW 1%	EA	1.00	.
R	16	130-05335-0013		RES CH 3.3M TW 5%	EA	.	1.00
R	16	130-05335-0023	4718-5398-905	RES CH 3.3M EW 5%	EA	1.00	.
R	17	139-03922-0000	4718-5317-192	RES CH 39.2K EW 1%	EA	1.00	.
R	17	139-03922-0010	4724-3922-113	RES CH 39.2K TW 1%	EA	.	1.00
R	18	130-05392-0013	4724-0392-233	RES CH 3.9K TW 5%	EA	.	1.00
R	18	130-05392-0023	4718-5237-371	RES CHIP 3.9KEW5%	EA	1.00	.
R	19	130-05432-0013	4724-0432-233	RES CH 4.3K TW 5%	EA	.	1.00
R	19	130-05432-0023	4718-5237-354	RES CHIP 4.3KEW5%	EA	1.00	.
R	20	139-05112-0000	4718-5317-198	RES CHIP 51.1K 1%	EA	1.00	.
R	20	139-05112-0010	4724-5112-113	RES CH 51.1K TW 1%	EA	.	1.00
R	21	139-03922-0000	4718-5317-192	RES CH 39.2K EW 1%	EA	1.00	.
R	21	139-03922-0010	4724-3922-113	RES CH 39.2K TW 1%	EA	.	1.00
R	22	133-00272-0006	4719-2048-006	RES VARI	EA	1.00	1.00
R	25	130-05103-0013	4724-0103-233	RES CH 10K TW 5%	EA	.	1.00
R	25	130-05103-0023	4718-5237-310	RES CH 10K EW 5%	EA	1.00	.
R	28	130-05103-0013	4724-0103-233	RES CH 10K TW 5%	EA	.	1.00
R	28	130-05103-0023	4718-5237-310	RES CH 10K EW 5%	EA	1.00	.
R	40	130-05102-0013	4724-0102-233	RES CH 1K TW 5%	EA	.	1.00
R	40	131-00102-0013	4704-2062-200	RES CF 1K EW 5%	EA	1.00	.
R	43	130-05102-0013	4724-0102-233	RES CH 1K TW 5%	EA	.	1.00
R	43	130-05102-0023	4718-5237-301	RES CH 1K EW 5%	EA	1.00	.
R	44	130-05102-0013	4724-0102-233	RES CH 1K TW 5%	EA	.	1.00
R	44	130-05102-0023	4718-5237-301	RES CH 1K EW 5%	EA	1.00	.
R	45	139-08252-0000	4718-5317-164	RES CH 82.5K EW 1%	EA	1.00	.
R	45	139-08252-0010	4724-8252-113	RES CH 82.5K TW 1%	EA	.	1.00
R	46	139-01003-0000	4718-5317-138	RES CHIP 100KEW1%	EA	1.00	.
R	46	139-01003-0010	4724-1003-113	RES CH 100K EW 1%	EA	.	1.00
R	47	139-09092-0000	4718-5317-165	RES CHIP 90.9KEW1%	EA	1.00	.
R	47	139-09092-0010	4724-9092-113	RES CH 90.9K TW 1%	EA	.	1.00
R	52	130-05102-0013	4724-0102-233	RES CH 1K TW 5%	EA	.	1.00
R	52	130-05102-0023	4718-5237-301	RES CH 1K EW 5%	EA	1.00	.
R	103	130-05273-0013	4724-0273-233	RES CH 27K TW 5%	EA	.	1.00
R	103	139-02672-0000	4718-5398-940	RES CHIP 26.7KEW1%	EA	1.00	.
R	112	130-05103-0013	4724-0103-233	RES CH 10K TW 5%	EA	.	1.00
R	112	130-05103-0023	4718-5237-310	RES CH 10K EW 5%	EA	1.00	.
R	113	130-05624-0013	4724-0624-233	RES CH 620K TW 5%	EA	.	1.00
R	113	139-06193-0000		RES CH 619KEW 1%	EA	1.00	.
R	127	139-02742-0000		RES CHIP 27.4KEW1%	EA	1.00	.
R	127	139-02742-0010	4724-2742-113	RES CH 27.4K TW 1%	EA	.	1.00
R	128	139-05112-0000	4718-5317-198	RES CHIP 51.1K 1%	EA	1.00	.
R	128	139-05112-0010	4724-5112-113	RES CH 51.1K TW 1%	EA	.	1.00
R	129	139-03922-0000	4718-5317-192	RES CH 39.2K EW 1%	EA	1.00	.
R	129	139-03922-0010	4724-3922-113	RES CH 39.2K TW 1%	EA	.	1.00
R	139	139-06812-0000		RES 68.1K EW 1%	EA	1.00	.
R	139	139-06812-0010	4724-6812-113	RES CH 68.1K TW 1%	EA	.	1.00
R	140	130-05682-0013	4724-0682-233	RES CH 6.8K TW 5%	EA	.	1.00
R	140	130-05682-0023	4718-5237-381	RES CHIP 6.8KEW5%	EA	1.00	.
R	141	130-05272-0013	4724-0272-233	RES CH 2.7K TW 5%	EA	.	1.00
R	141	130-05272-0023	4718-5237-386	RES CHIP 2.7KEW5%	EA	1.00	.
R	142	130-05102-0013	4724-0102-233	RES CH 1K TW 5%	EA	.	1.00
R	142	130-05102-0023	4718-5237-301	RES CH 1K EW 5%	EA	1.00	.
R	143	130-05912-0013	4724-0912-233	RES CH 9.1K TW 5%	EA	.	1.00
R	143	130-05912-0023	4718-5317-105	RES CHIP 9.1K5%EW	EA	1.00	.
R	144	130-05104-0013	4724-0104-233	RES CH 100K TW 5%	EA	.	1.00
R	144	130-05104-0023	4718-5237-322	RES CH 100K EW 5%	EA	1.00	.
R	145	130-05103-0013	4724-0103-233	RES CH 10K TW 5%	EA	.	1.00
R	145	130-05103-0023	4718-5237-310	RES CH 10K EW 5%	EA	1.00	.